

KEITHLEY INSTRUMENTS

Model 3910 Function Synthesizer Operator's Manual

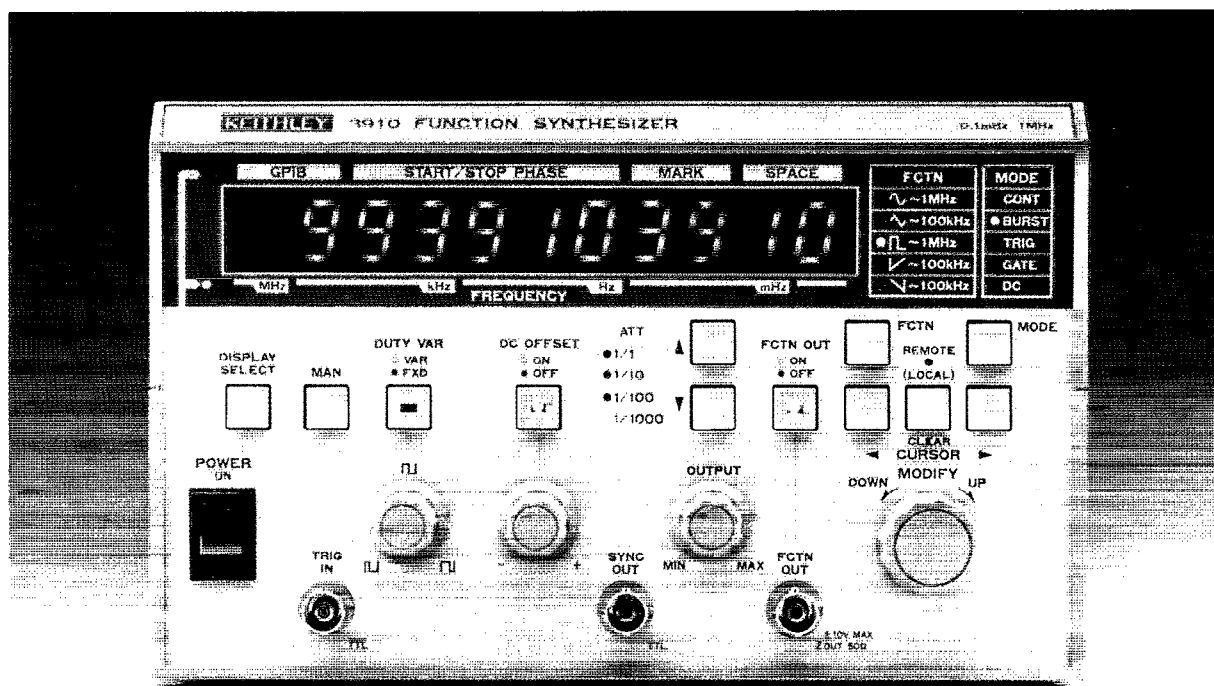

Contains Operating Information

Publication Date: June 1991

Document Number: 3910-900-01 Rev. A

WARRANTY

Keithley Instruments, Inc. warrants this product to be free from defects in material and workmanship for a period of 1 year from date of shipment.

Keithley Instruments, Inc. warrants the following items for 90 days from the date of shipment: probes, cables, rechargeable batteries, diskettes, and documentation.

During the warranty period, we will, at our option, either repair or replace any product that proves to be defective.

To exercise this warranty, write or call your local Keithley representative, or contact Keithley headquarters in Cleveland, Ohio. You will be given prompt assistance and return instructions. Send the product, transportation prepaid, to the indicated service facility. Repairs will be made and the product returned, transportation prepaid. Repaired or replaced products are warranted for the balance of the original warranty period, or at least 90 days.

LIMITATION OF WARRANTY

This warranty does not apply to defects resulting from product modification without Keithley's express written consent, or misuse of any product or part. This warranty also does not apply to fuses, software, non-rechargeable batteries, damage from battery leakage, or problems arising from normal wear or failure to follow instructions.

THIS WARRANTY IS IN LIEU OF ALL OTHER WARRANTIES, EXPRESSED OR IMPLIED, INCLUDING ANY IMPLIED WARRANTY OF MERCHANTABILITY OR FITNESS FOR A PARTICULAR USE. THE REMEDIES PROVIDED HEREIN ARE BUYER'S SOLE AND EXCLUSIVE REMEDIES.

NEITHER KEITHLEY INSTRUMENTS, INC. NOR ANY OF ITS EMPLOYEES SHALL BE LIABLE FOR ANY DIRECT, INDIRECT, SPECIAL, INCIDENTAL OR CONSEQUENTIAL DAMAGES ARISING OUT OF THE USE OF ITS INSTRUMENTS AND SOFTWARE EVEN IF KEITHLEY INSTRUMENTS, INC., HAS BEEN ADVISED IN ADVANCE OF THE POSSIBILITY OF SUCH DAMAGES. SUCH EXCLUDED DAMAGES SHALL INCLUDE, BUT ARE NOT LIMITED TO: COSTS OF REMOVAL AND INSTALLATION, LOSSES SUSTAINED AS THE RESULT OF INJURY TO ANY PERSON, OR DAMAGE TO PROPERTY.

KEITHLEY INSTRUMENTS

Instruments Division, Keithley Instruments, Inc. • 28775 Aurora Road • Cleveland, Ohio 44139 • (216) 248-0400 • Fax: 248-6168

WEST GERMANY: Keithley Instruments GmbH • Landsbergerstr. 65 • D-8034 Germering • 089-849307-0 • Telex: 52-12160 • Fax: 089-84930759
GREAT BRITAIN: Keithley Instruments, Ltd. • The Minster • 58, Portman Road • Reading, Berkshire RG 3 1EA • 011 44 734 575 666 • Fax: 011 44 734 596 469
FRANCE: Keithley Instruments SARL • 3 Allee des Garays • B.P. 60 • 91124 Palaiseau/Z.I. • 1-6-0115 155 • Telex: 600 933 • Fax: 1-6-0117726
NETHERLANDS: Keithley Instruments BV • Avelingen West 49 • 4202 MS Gorinchem • P.O. Box 559 • 4200 AN Gorinchem • 01830-35333 • Telex: 24 684 • Fax: 01830-30821
SWITZERLAND: Keithley Instruments SA • Kriesbachstr. 4 • 8600 Dubendorf • 01-821-9444 • Telex: 828 472 • Fax: 0222-315366
AUSTRIA: Keithley Instruments GesmbH • Rosenhugelstrasse 12 • A-1120 Vienna • (0222) 84 65 48 • Telex: 131677 • Fax: (0222) 8403597
ITALY: Keithley Instruments SRL • Viale S. Gimignano 4/A • 20146 Milano • 02-4120360 or 02-4156540 • Fax: 02-4121249

**Operator's Manual
Model 3910
Function Synthesizer**

**©1991, Keithley Instruments, Inc.
All Rights Reserved
Instruments Division
Cleveland, Ohio, U. S. A.
Document Number: 3910-900-01**

All Keithley product names are trademarks or registered trademarks of Keithley Instruments, Inc.

Other brand and product names are trademarks or registered trademarks of their respective holders.

Safety Precautions

The following safety precautions should be observed before using the Model 3910 Function Synthesizer and any associated instruments.

This instrument is intended for use by qualified personnel who recognize shock hazards and are familiar with the safety precautions required to avoid possible injury. Read over this manual carefully before using the instrument.

Exercise extreme caution when a shock hazard is present at the test circuit. The American National Standards Institute (ANSI) states that a shock hazard exists when voltage levels greater than 30V rms or 42.4V peak are present. **A good safety practice is to expect that hazardous voltage is present in any unknown circuit before measuring.**

Inspect the connecting cables and test leads for possible wear, cracks, or breaks before each use.

For maximum safety, do not touch the test cables or any instruments while power is applied to the circuit under test. Turn off the power and discharge any capacitors before connecting or disconnecting cables from the instrument.

Do not touch any object which could provide a current path to the common side of the circuit under test or power line (earth) ground. Always make measurements with dry hands while standing on a dry, insulated surface capable of withstanding the voltage being measured.

Instrumentation and accessories should not be connected to humans.

Table of Contents

SECTION 1 — General Information

1.1	INTRODUCTION	1-1
1.2	FEATURES	1-1
1.3	WARRANTY INFORMATION	1-2
1.4	MANUAL ADDENDA	1-2
1.5	SAFETY TERMS AND SYMBOLS	1-2
1.6	UNPACKING AND REPACKING	1-2
1.6.1	Unpacking	1-2
1.6.2	Shipment Contents	1-2
1.6.3	Operator's Manual	1-2
1.6.4	Repacking For Shipment	1-2
1.7	OPTIONAL ACCESSORIES	1-3
1.8	SPECIFICATIONS	1-3

SECTION 2 — Getting Started

2.1	INTRODUCTION	2-1
2.2	INSTALLATION	2-1
2.2.1	Installation Location	2-1
2.2.2	Cooling	2-1
2.3	LINE POWER SUPPLY	2-2
2.3.1	LINE Voltage Selector Switch	2-2
2.3.2	Line Receptacle Connection	2-2
2.3.3	Line Fuse	2-2
2.4	HANDLING PRECAUTIONS	2-2
2.5	BASIC OPERATION	2-3
2.5.1	Front Panel Summary	2-3
2.5.2	Typical Test Connections	2-3
2.5.3	Operating Examples	2-4

SECTION 3 — Operation

3.1	INTRODUCTION	3-1
3.2	FRONT PANEL AND REAR PANEL DESCRIPTION	3-1
3.2.1	Front Panel Description	3-1
3.2.2	Rear Panel Description	3-4
3.3	INPUT AND OUTPUT CONNECTIONS	3-5
3.3.1	Input Connection	3-5
3.3.2	Output Connections	3-5
3.4	STARTUP	3-6
3.5	OPERATING PROCEDURES	3-7
3.5.1	Error Codes	3-7

3.5.2	Frequency Setting	3-7
3.5.3	Output Amplitude	3-8
3.5.4	DC Offset	3-8
3.5.5	Waveform Selection, Square-Wave Duty Cycle, and Synchronous Output	3-8
3.5.6	Oscillation Mode	3-9
3.5.7	Trigger Parameters	3-11

SECTION 4 — GPIB Interface

4.1	INTRODUCTION	4-1
4.1.1	GPIB Overview	4-1
4.1.2	Major GPIB Specifications	4-1
4.1.3	Bus Line Signals and Operation	4-1
4.1.4	GPIB Handshaking	4-2
4.1.5	Data Transfer Example	4-3
4.1.6	Basic Talker Functions	4-3
4.1.7	Basic Listener Functions	4-3
4.1.8	Basic Controller Functions	4-3
4.1.9	Multi-line Interface Messages	4-3
4.2	OVERVIEW OF MODEL 3910 GPIB INTERFACE	4-6
4.2.1	Introduction	4-6
4.2.2	Specifications	4-6
4.3	MODEL 3910 PROGRAM CODES	4-9
4.4	TYPICAL EXECUTION TIMES	4-12
4.5	SAMPLE PROGRAMS	4-13

List of Illustrations

SECTION 2 — Getting Started

Figure 2-1	Front Panel Summary	2-3
Figure 2-2	Typical Connections	2-4

SECTION 3 — Operation

Figure 3-1	Model 3910 Front Panel	3-2
Figure 3-2	Model 3910 Rear Panel	3-4
Figure 3-3	Logic Input Circuit	3-5
Figure 3-4	Output Circuit	3-6
Figure 3-5	Phase Relationship between FCTN OUT Waveform and SYNC OUT	3-9
Figure 3-6	Relationship between Trigger Signal and Oscillation in TRIG Mode	3-10
Figure 3-7	Relationship between Trigger Signal and Oscillation in GATE Mode	3-11
Figure 3-8	Definition of Phase of each Waveform	3-12

SECTION 4 — GPIB Interface

Figure 4-1	Interface Connector	4-2
Figure 4-2	Handshake Timing Diagram	4-3
Figure 4-3	Data Transfer Example	4-4
Figure 4-4	Program Code Syntax	4-8

List of Tables

SECTION 2 — Getting Started

Table 2-1	Fuse Replacement	2-2
-----------	------------------------	-----

SECTION 4 — GPIB Interface





Table 4-1	Multiple-line Interface Message	4-5
Table 4-2	Interface Functions	4-6
Table 4-3	Bus Driver Specifications	4-6
Table 4-4	Response to Interface Messages	4-7
Table 4-5	Status Byte	4-9
Table 4-6	Model 3910 Main Parameter Setting Messages	4-10
Table 4-7	Typical Execution Times	4-12

SECTION 1

General Information

1.1 INTRODUCTION

The Model 3910 Function Synthesizer can generate frequencies between 0.1mHz and 1MHz. The Model 3910 can generate the entire band at a resolution of 0.1mHz, with a high-frequency accuracy of ± 30 ppm.

Five AC waveforms, sine , triangle , square , rising sawtooth , and falling sawtooth  are available. A maximum of ± 10 V DC can be added onto each output. Maximum output voltage for all waveforms is 20V p-p/no load or 10Vp-p/50 Ω load.

Since frequencies are synthesized directly by a custom LSI digital IC, accuracy and stability are high, and the frequency switching time is short. Another advantage is the continuity of phase at frequency switchover.





In addition to continuous oscillation, burst oscillation, trigger oscillation, and gate oscillation are available. The Model 3910 also provides a continuous output of direct current voltage. An external trigger input provides an external trigger signal during trigger or gate oscillation. The square-wave duty cycle is also variable.

The Model 3910 uses a single line, 11-character LED display to display the values of oscillation frequency, pa-

rameters, and other values. Settings are easily made using push-button keys and rotary knobs.

A GPIB (IEEE-488) interface is available as an option for the Model 3910. With the exception of the AMPTD, amplitude setting; DC OFFSET, added quantity setting; and DUTY VAR, duty ratio setting; a GPIB equipped Model 3910 can be programmed over the bus for the same operating modes and parameters that can be controlled from the front panel.

1.2 FEATURES

- Wide bandwidth: 0.1mHz to 1MHz (resolution 0.1mHz).
- ± 30 ppm frequency accuracy.
- Phase continuity at frequency switchover.
- Five AC waveforms available: , , , , and 
- The duty cycle can be set to values between 10% and 90% for frequencies up to 100kHz.
- High output: 20Vp-p/no load, 10Vp-p/50 Ω load.
- Low distortion: 0.3% or less (10Hz to 100kHz).
- DC output voltages available: ± 10 V/no load, ± 5 V/50 Ω load.
- Burst oscillation mode: Repeats oscillation of wave number specified by mark wave (1-16) and space wave number (1-16).
- Trigger oscillation and gate oscillation:
Trigger source: External by front panel BNC plug or push-button key.

Start/stop phase: -360° to $+360^\circ$.

Input voltage: TTL level (pulls up 74HC14 input by 5.1K). Minimum pulse width 200nsec.

Trigger: Oscillates wave number specified by wave number (1-16) by trigger signal.

Gate: Integral wave number oscillation by trigger signal.

- Waveform and frequency range:
 - Sine wave, square wave (duty fixed); 0.1mHz to 1MHz.
 - Triangle wave, square wave (duty variable), rising sawtooth wave, falling sawtooth wave; 0.1mHz to 100kHz, oscillation possible up to 1MHz.
- Each parameter setting can be modified using the MODIFY knob and the CURSOR keys. The single line, 11 character LED display, clearly displays all necessary information; oscillation frequency, GPIB address (when installed), start/stop phase, mark wave number, and space wave number.
- Battery backed-up memory stores the configuration in effect when power is turned off.
- Optional GPIB interface allows the Model 3910 to be programmed over the GPIB (IEEE-488 interface bus).

1.3 WARRANTY INFORMATION

Warranty information is located on the inside front cover of this operator's manual. Should your Model 3910 require warranty service, contact the Keithley representative or authorized repair facility in your area for further information. When returning the instrument for repair, be sure to fill out and include the service form at the back of this manual in order to provide the repair facility with the necessary information.

1.4 MANUAL ADDENDA

Any improvement or changes concerning the instrument or manual will be explained in an addendum included with the unit. Be sure to note these changes and incorporate them into the manual before using the unit.

1.5 SAFETY TERMS AND SYMBOLS

The following safety terms and symbols are found on the instrument or used in this manual.

The  symbol on the instrument indicates that the user should refer to the operating instructions.

The **WARNING** heading used in this manual explains dangers that might result in personal injury or death. Always read the associated information very carefully before performing the indicated procedure.

The **CAUTION** heading used in this manual explains hazards that could damage the instrument. Such damage may invalidate the warranty.

1.6 UNPACKING AND REPACKING

1.6.1 Unpacking

After carefully unpacking the instrument from its shipping carton, inspect it for any obvious signs of physical damage. Report any such damage to the shipping agent immediately. Save the original packing carton for storage or possible future shipment.

1.6.2 Shipment Contents

The following items are included with every Model 3910 order:

- Model 3910 Function Synthesizer
- Model 3910 Operator's Manual
- Power Cord
- Fuse (1A, 250V, 5.2 × 20mm)
- BNC to BNC signal cable
- Additional accessories as ordered.

1.6.3 Operator's Manual

If an additional manual is required, order the manual package, Keithley part number 3910-900-00. The manual package includes an operator's manual and any pertinent addenda.

1.6.4 Repacking For Shipment

Should it become necessary to return the Model 3910 for repair, carefully pack the unit in its original packing carton or the equivalent. If the original carton is not available or damaged, be sure to use a cardboard box of sufficient strength and room. Pad the empty spaces in the carton with adequate packing material to hold the unit firmly in place.

Include the following information:

- Advise to the warranty status of the instrument.
- Write ATTENTION REPAIR DEPARTMENT on the shipping label.
- Fill out and include the service form located at the back of this manual.

1.7 OPTIONAL ACCESSORIES

The following accessories are available for use with the Model 3910.

Models 3900-1 and 3900-2 Rack Mounting Kits: The Model 3900-1 mounts one Model 3910 in a standard 19-inch rack. The Model 3900-2 mounts two Model 3910s side by side in a standard 19-inch rack. Both kits include all necessary hardware for proper rack mounting of the instruments.

Model 7007 Shielded IEEE-488 Cables: The Model 7007-1 (1m, 3.3ft.) and Model 7007-2 (2m, 6.6ft.) can be used to interface the Model 3910 to the IEEE-488 bus.

Model 3911 IEEE-488 Interface: With the Model 3911 option a maximum of 15 Model 3910s can be connected on the same bus, data line transfer uses a 3-line handshake method, enabling reliable data transfer between data sending (talkers) and receivers (listeners) having differing data transfer rates.

Model 7051-2 BNC-to-BNC Cable: The Model 7051-2 is 50 Ω BNC to BNC cable (RG-58C) 2ft. (0.6m) in length. The Model 7051-2 is terminated with male BNC connectors on both ends.

Model 7051-5 BNC-to-BNC Cable: The Model 7051-5 is 50 Ω BNC to BNC cable (RG-58C) 5ft. (1.2m) in length. The Model 7051-5 is terminated with male BNC connectors on both ends.

Model 7051-10 BNC-to-BNC Cable: The Model 7051-10 is similar to the Models 7051-2 and 7051-5 except that it is 10ft. (2.4m) in length.

Model 7754-3 BNC-to-Alligator Cable: The Model 7754-3 is a 3ft. (0.9m) 50 Ω cable (RG-58C), terminated with a male BNC connector on one end and two alligator clips on the other end.

Model 7755 50 Ω Feed-Through Terminator: The Model 7755 is a BNC to BNC adapter that is terminated with a 50 Ω resistor. VSWR is <1.1, DC to 250MHz.

1.8 SPECIFICATIONS

Detailed Model 3910 specifications may be found in Appendix B.

SECTION 2

Getting Started

2.1 INTRODUCTION

This section contains basic information on installation, power line connections, and it also provides typical simple operating examples.

2.2 INSTALLATION

The following paragraphs discuss Model 3910 installation. In particular, use adequate care when installing the unit. Improper installation will adversely affect the life, reliability, and safety of the unit.

The Model 3910 weighs about 7 lbs; be careful when carrying the unit or mounting it in a rack.

2.2.1 Installation Location

The allowable ambient temperature and humidity ranges for the Model 3910 are.

Operating: 0 to 40°C, 10 to 90%RH
Storage: -10 to 50°C, 10 to 80%RH

Be sure to install the unit in a location that satisfies these temperature and humidity conditions. Also the environ-

ment must be free of dust and vibration, and the Model 3910 must not be exposed to direct sunlight.

The Model 3910 uses a line filter, but pulse noise or strong magnetic or electric fields may cause incorrect operation of the unit. Do not install the unit near a source of pulse noise or strong magnetic or electric fields.

The guard on the rear panel of the unit is designed to protect rear panel connectors and should not be used as a leg for installation. Do not stand the unit vertically on the rear guard because it may fall over, causing instrument damage or personal injury.

2.2.2 Cooling

The Model 3910 is air-cooled by vents. Insufficient air flow may cause a component in the unit to fail. Follow the instructions given below.

CAUTION

Observe the following precautions to prevent damage to the unit:

- A vent is provided on the bottom panel of the unit. Install the unit on a rigid, flat surface, and avoid installing it on soft material such as a cushion. Be careful not to insert foreign

material between the bottom of the unit and the surface underneath. Another vent is located on the top panel of the unit. Be careful not to block the top vent by placing an object on top of the unit.

- Avoid mounting two or more units vertically. Placing one unit on top of another will obstruct the vents.

2.3 LINE POWER SUPPLY

The Model 3910 operates with a 100V, 120V, 220V, or 240V $\pm 10\%$, 48 to 62Hz, single-phase AC power supply. The power consumption is approximately 25VA.

2.3.1 LINE Voltage Selector Switch

The LINE voltage selector switch on the rear panel allows you to change operating voltage of the power supply. The standard setting of the switch is the same as the voltage available in the country to which the unit is shipped.

To change the power supply voltage, first disconnect the line cord, and set the supply voltage switch in the correct position. Wait at least five seconds before turning the power back on after turning it off.

WARNING

To avoid a shock hazard, disconnect the power cord from the instrument before changing the supply voltage setting.

CAUTION

Be sure to set the line voltage switch to the correct position for the line power voltage to be used. Operating the instrument on an incorrect voltage may cause damage to the unit.

2.3.2 Line Receptacle Connection

Connect the supplied power cord to the rear panel Line receptacle and to a grounded AC power receptacle supplying the correct voltage.

WARNING

The Model 3910 is equipped with a 3-wire power cord that contains a separate ground wire and is designed to be used with grounded outlets. When proper connections are made, instrument chassis is connected to the power line ground. If the AC outlet is not grounded, the rear panel ground terminal  must be connected to safety earth ground using #18AWG (or larger) wire before use.

2.3.3 Line Fuse

The line fuse, which is integral with the power line receptacle, protects the instrument from over-current situations. To replace the fuse, first disconnect the line cord, then pry out the fuse compartment (immediately to the right of the FUSE marking) with a small screwdriver. A spare fuse is located in the compartment with the fuse being used. Replace the blown fuse only with the type listed in Table 2-1, then replace the fuse holder.

WARNING

To avoid a shock hazard, disconnect the line cord from the instrument before replacing the fuse.

CAUTION

Use only a fuse of the rating listed in Table 2-1, or instrument damage may occur.

Table 2-1. Fuse Replacement

Line Voltage	Fuse Current Rating	Keithley Part No.
100V, 120V	1A	FU-96-2
220, 240V	1/2A	FU-96-1

NOTE: Fuses are 5 x 20mm and have 250V, normal blow ratings.

2.4 HANDLING PRECAUTIONS

When the front panel or case becomes dirty, clean it with a soft cloth. If the panel or case is too dirty for cleaning with a dry cloth, dampen the cloth in mild detergent, and wipe the panel or case with the damp cloth. Never use solvents such as thinner or benzene, or chemical dust cloths to avoid damaging the case or front panel surfaces.

2.5 BASIC OPERATION

The following paragraphs summarize front panel operating controls, give typical test connections, and discuss typical operating examples for the Model 3910.

2.5.1 Front Panel Summary

Figure 2-1 summarizes each front panel feature. For de-

tailed information on each operating feature, refer to Section 3.

2.5.2 Typical Test Connections

Figure 2-2 shows typical tests connections between the Model 3910 main synthesizer and a DUT. Note that 50Ω characteristic impedance cables such as the Model 7051 should be used for output connections.

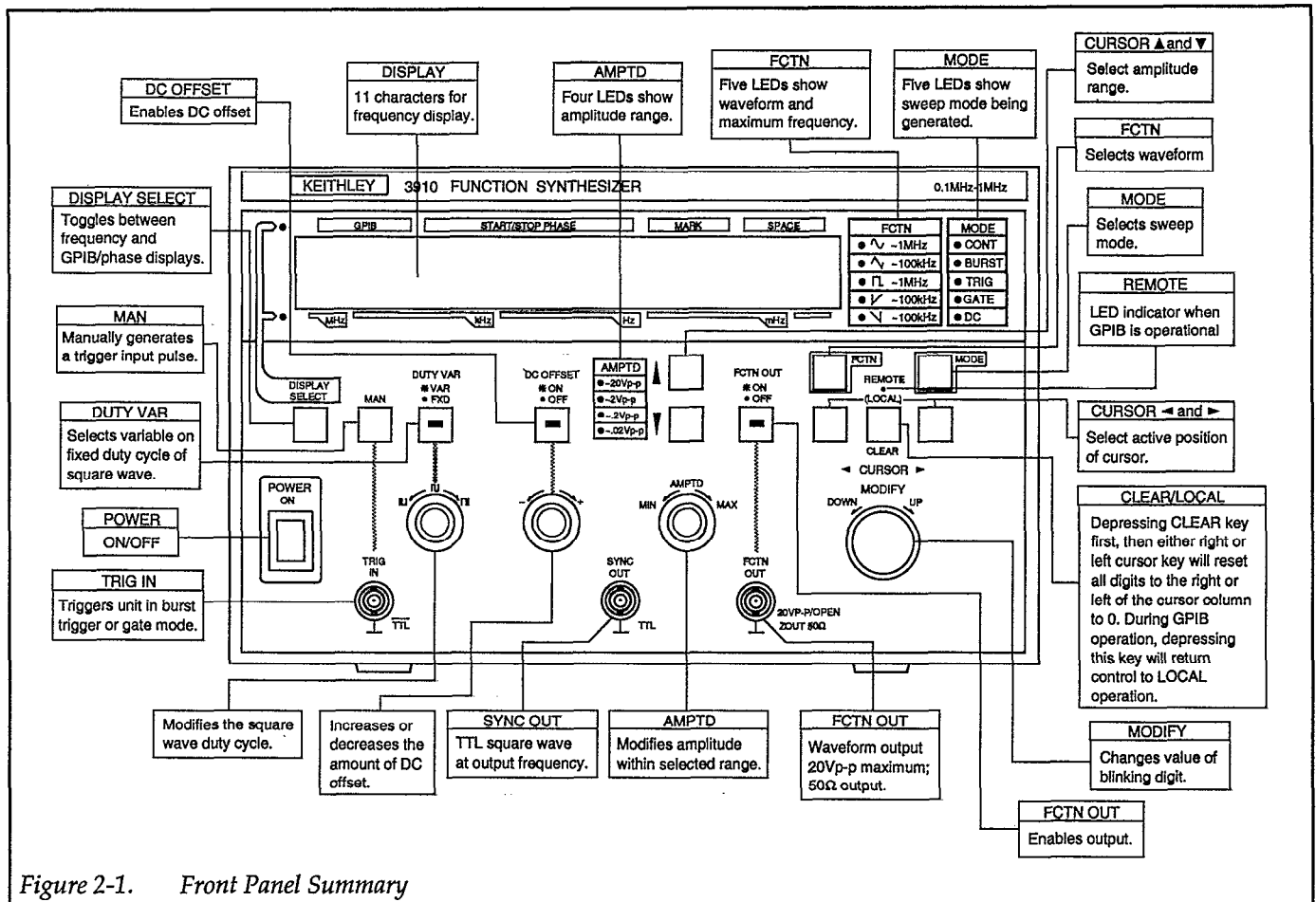

Figure 2-1. Front Panel Summary

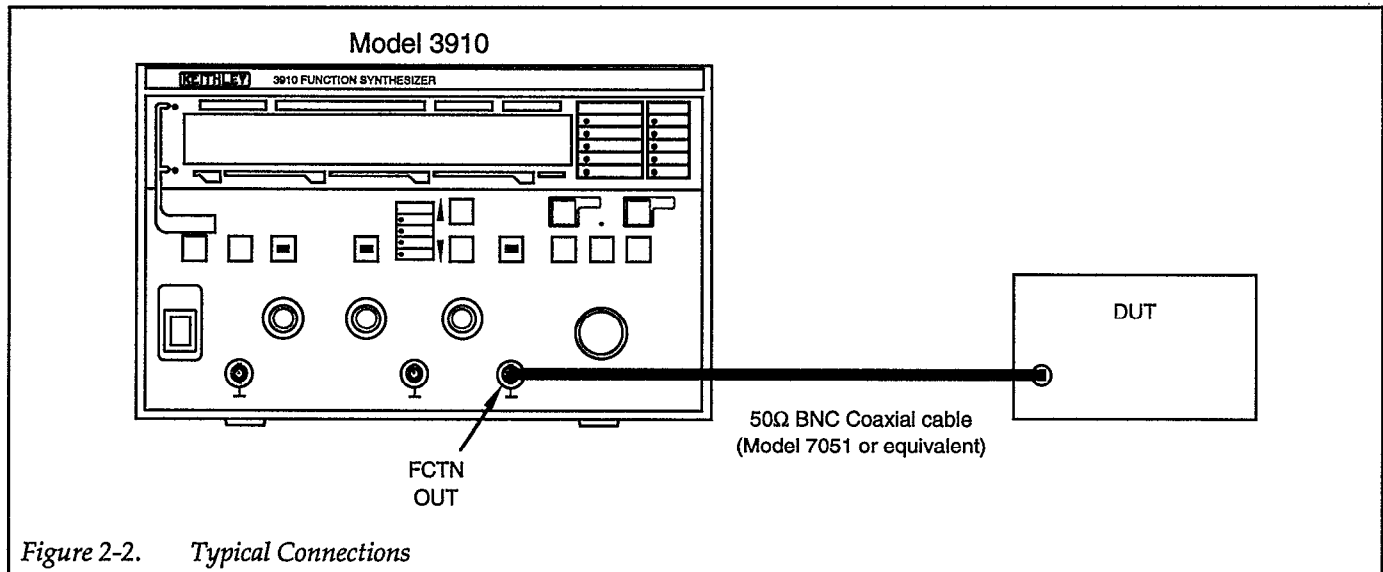

Figure 2-2. Typical Connections

2.5.3 Operating Examples

The following examples give step-by-step instructions for setting basic Model 3910 operating parameters. The Model 3910 can be connected to an oscilloscope to view the results of the various operating examples.

Example 1: Selecting the Waveform Type (Function)

The first sequence will adjust the Model 3910 to output a sine wave, with a continuous sweep.

1. Press DISPLAY SELECT to indicate frequency (lower LED).
2. Press FCTN to cycle through the five options until the LED indicates a SINE wave (top LED).
3. Press MODE to indicate CONT (continuous sweep).

Example 2: Setting the Waveform Frequency or Period

This sequence will set the Model 3910 to a frequency of 500Hz, without regard to any previous setup. You will have to determine whether to use step 1 or 2 in this sequence because there is no way to know what setup was used for the previous test. Since the Model 3910 retains only one setting in memory, that setting is always the last one.

1. If the display shows a frequency higher than 500Hz, use this next sequence. Otherwise skip to step 2.

- A. Move the cursor to the seventh position: The seventh position, 100Hz column, will blink. Press the CLEAR key and at the same time press the left cursor key. All digits to the left of the blinking digit will return to 0 (erase).
 - B. The seventh position, 100Hz column, will be blinking. Rotate the MODIFY knob UP (clockwise) to increase or DOWN (counter-clockwise) to decrease the digit to the correct value, 5 in the 100Hz column.
 - C. If any of the lower digits (less significant digits) in the displayed number are above zero, press the CLEAR key and at the same time press the right cursor key. All digits to the right of the blinking digit will return to 0. The display should now show the following digits: 5000000 (500.0000Hz).
2. If the display shows a frequency less than 500Hz (5000000), use this sequence:
 - A. Assume the display indicates a frequency of 86Hz. Press the left, or right, cursor as necessary to make the column to the left of 8 blink. A u will appear in this column.
 - B. Rotate the MODIFY knob UP (clockwise) and a number will appear in the 100Hz column. Adjust this number to 5.
 - C. Press the CLEAR key and at the same time press the right cursor key. All digits to the right of the blinking digit will return to 0. The display should now show the following digits: 5000000 (500.0000Hz).

NOTE

The frequency may be increased quickly, using the above method, but no similar action is available to rapidly reduce the frequency setting.

Example 3: Setting the Output Amplitude

This step sets the amplitude of the existing waveform to a value of 10mVp-p:

Use the cursor down key to set the amplitude range so it indicates 0.02Vp-p (20mVp-p). Rotate the AMPTD knob until the scope indicates 10mVp-p.

Example 4: Changing the Output to a Square Wave

This example changes the output to a square wave with variable duty cycle, while maintaining the present frequency, in continuous mode.

1. Press FCTN twice to indicate a square wave output. Note that the output waveform has equal time-on and time-off.
2. Press DUTY VAR to allow variable duty cycle (LED on). Rotate the associated knob below the key to cre-

ate square waves with different on- and off-times. Leave the square wave in some extreme variable position; that is, an obviously unequal on- or off-time.

3. Press DUTY VAR key again. The scope presentation reverts to a square wave with equal on- and off-times.
4. Press the DUTY VAR key again. The scope should display the unequal duty cycle from the previous step.

Example 5: Adjust the DC Offset

This step adjusts the DC offset value based on the centerline (zero or average) voltage level of the existing waveform.

1. Press the DC OFFSET key (LED on). Rotate the associated knob and note the vertical movement of CH A on the scope. This movement corresponds directly with the offset voltage applied by the rotation of the knob. Leave the signal with a significant offset and go to the next step.
2. Press DC OFFSET again (LED off). The scope presentation reverts to the original value of zero offset. Press the key again and the offset value re-appears and the CH A display moves off zero. Press the key once more to return the scope to zero offset (LED off).

SECTION 3

Operation

3.1 INTRODUCTION

This section contains detailed information on front panel operation of the Model 3910. For detailed GPIB (IEEE-488 bus) operation, refer to Section 4.

LED display presents information useful for the operation of the Model 3910, such as the value of each parameter and the range of permissible parameter values. Along the bottom edge of the front panel are various input/output BNC connectors.

3.2 FRONT PANEL AND REAR PANEL DESCRIPTION

Most settings are maintained in battery backed-up memory. As a result, the Model 3910 automatically assumes the previous settings when the power is first turned on.

3.2.1 Front Panel Description

The front panel of the Model 3910 is shown in Figure 3-1. The front panel is made up of a LED display and a control panel with various push-button switches and knobs. The

Each front panel feature is described below. The circled number to the left of each description corresponds to the appropriate number shown in Figure 3-1.

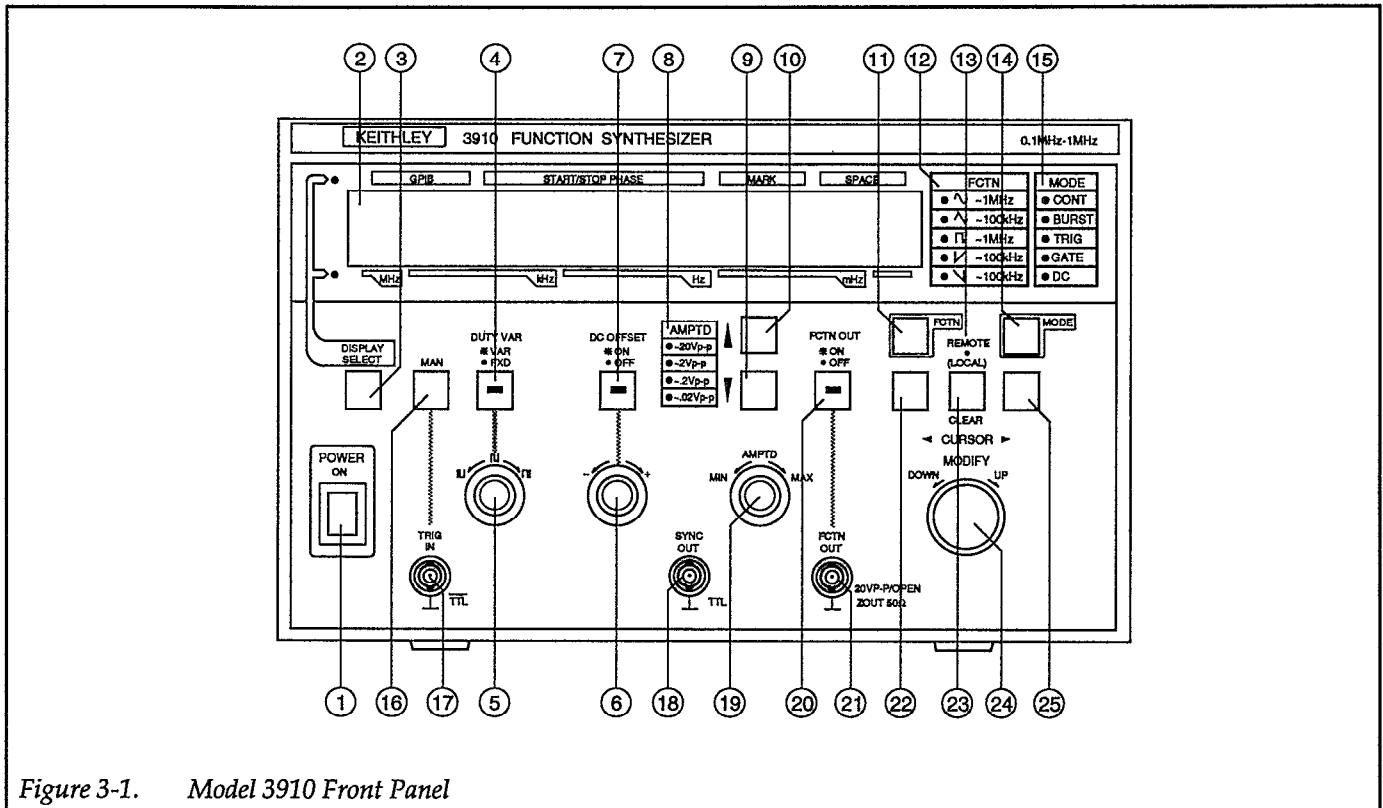







Figure 3-1. Model 3910 Front Panel

- 1 POWER ON/OFF (Power switch)**
POWER controls AC power to the Model 3910. Push this switch up to turn power on, and push down to turn power off.
- 2 Display**
The single-line 11-character display shows oscillation frequency, parameter values, and other important information during operation. An active display also indicates that instrument power is turned on.
- 3 DISPLAY SELECT**
Push-button key that selects the parameter displayed to either oscillation frequency or GPIB address (only when GPIB option is installed), start/stop phase, mark wave number, and space wave number. When LED at the lower left of the display is lit oscillation frequency is selected. When LED at the upper left of the display is lit GPIB address, start/stop phase, and mark and space wave numbers are selected.
- 4 DUTY VAR FXD, VAR (Square wave duty cycle)**
Push-button key to select either variable duty or fixed square wave output. When LED in center of key is lit variable duty is selected.
- 5 \square , \square , \square (Variable duty ratio adjustment)**
Rotating the variable duty adjustment knob allows you to program the square wave duty cycle. The allowed duty cycle ranges from 5% to 95% under 10kHz, and from 10% to 90% at 10kHz to 100kHz. In the variable duty mode, the upper frequency limit for square waves is restricted to 100kHz.

- 6** +/- (DC offset value adjustment)
Rotating the DC offset value adjustment knob sets the programmed offset voltage. The allowable DC offset to be added to a waveform is between -10V and +10V.
- 7** DC OFFSET ON, OFF
Push-button key to select whether or not DC offset is added to the waveform. When LED in center of the key is lit offset is selected. Use the +/- offset value adjustment knob to add the determined amount of offset to the waveform.
- 8** AMPTD (Amplitude range display)
LEDs light to display the selected amplitude range. The allowed amplitude range is from 2mVp-p to 20Vp-p. The values for the amplitude setting are for no-load (open) output conditions. When the output is terminated with a 50 Ω terminal resistor, amplitude range is one half of the selected range.
- 9** ▼ (Amplitude range down key)
When the down cursor key is pressed the maximum value of the amplitude output signal is reduced.
- 10** ▲ (Amplitude range up key)
When the up cursor key is pressed the maximum value of the amplitude output signal is increased.
- 11** FCTN (Function: waveform)
This key allows you to choose the output waveform. Available waveforms include:  (sine wave),  (triangular wave),  (square wave),  (ascending sawtooth wave),  (descending sawtooth wave).
The selected waveform is displayed in the function LEDs.
- 12** FCTN (Displays the selected function)
Refer to the lit LED to see which wave function has been selected.
- 13** REMOTE (Remote state display)
This lamp indicates the remote state when the GPIB option is installed and listener is specified from the controller.
- 14** MODE (Oscillation mode)
This key allows you to choose the oscillation mode. Available modes include: CONT (continuous oscillation), BURST (burst oscillation), TRIG (trigger oscillation), GATE (gate oscillation). In addition, it is also possible to select DC for a continuous output of direct current voltage.
- 15** MODE (Displays the selected mode)
Refer to the lit LED to see which mode has been selected.
- 16** MAN (Manual trigger key)
This key allows the operator to manually generate a trigger input pulse during trigger or gate mode of oscillation.
- 17** TRIG IN (Trigger input)
This BNC connector is an input for external TTL-level signals, which can be used to trigger the Model 3910 in TRIG (trigger) and GATE modes of operation. When this input goes from high level to low level, it operates as a trigger signal.
- 18** SYNC OUT (Synchronous output)
This BNC jack provides a TTL-level signal at the same frequency as the FCTN OUT output waveform.
- 19** AMPTD MIN, MAX (Amplitude adjustment)
Turning this knob allows you to set the output amplitude of the unit when the FCTN OUT key has been activated. The allowed amplitude ranges from 2mVp-p to 20Vp-p.
- 20** FCTN OUT ON, OFF (Signal output ON/OFF)
FCTN OUT turns the output waveform off or on to the BNC plug of FCTN OUT. When the output is off, the main output signal is turned off and open-circuited. This can be shorted to ground by switching an internal short plug. The current status of this key can be determined by the LED in the center of the key. If lit, FCTN OUT is on.
- 21** FCTN OUT (Function output: waveform output)
This BNC jack provides the waveform output signal. The maximum output voltage range is ± 20 Vp-p/open circuit, and the output impedance is 50 Ω .

- 22** ◀(Left Cursor)
This key moves the cursor one column to the left each time it is pressed. If held continuously for more than 0.3 seconds, the cursor will continue moving to the left.
- 23** CLEAR (Local)
If this key is pushed first and then either the right or left cursor key is pushed at the same time, all digits to the right or left of this column will be reset to 0. In GPIB remote mode, this key is a return to local control key.
- 24** MODIFY UP, DOWN (Modify knob)
This knob is used to increase or decrease the set value of the display. Turning the knob clockwise increases the value while turning the knob counter-clockwise decreases the value. This

knob can be used to set the following parameters: frequency, GPIB address (0-30), start/stop phase ($\pm 360.0^\circ$), mark wave number (1-16), and space wave number (1-16).

- 25** ▶(Right Cursor)
This key moves the cursor one column to the right each time it is pressed. If held continuously for more than 0.3 seconds, the cursor will continue moving to the right.

3.2.2 Rear Panel Description

The rear panel of the Model 3910 is shown in Figure 3-2. Each rear panel feature is described below. The circled number to the left of each description corresponds to the appropriate number shown in Figure 3-2.

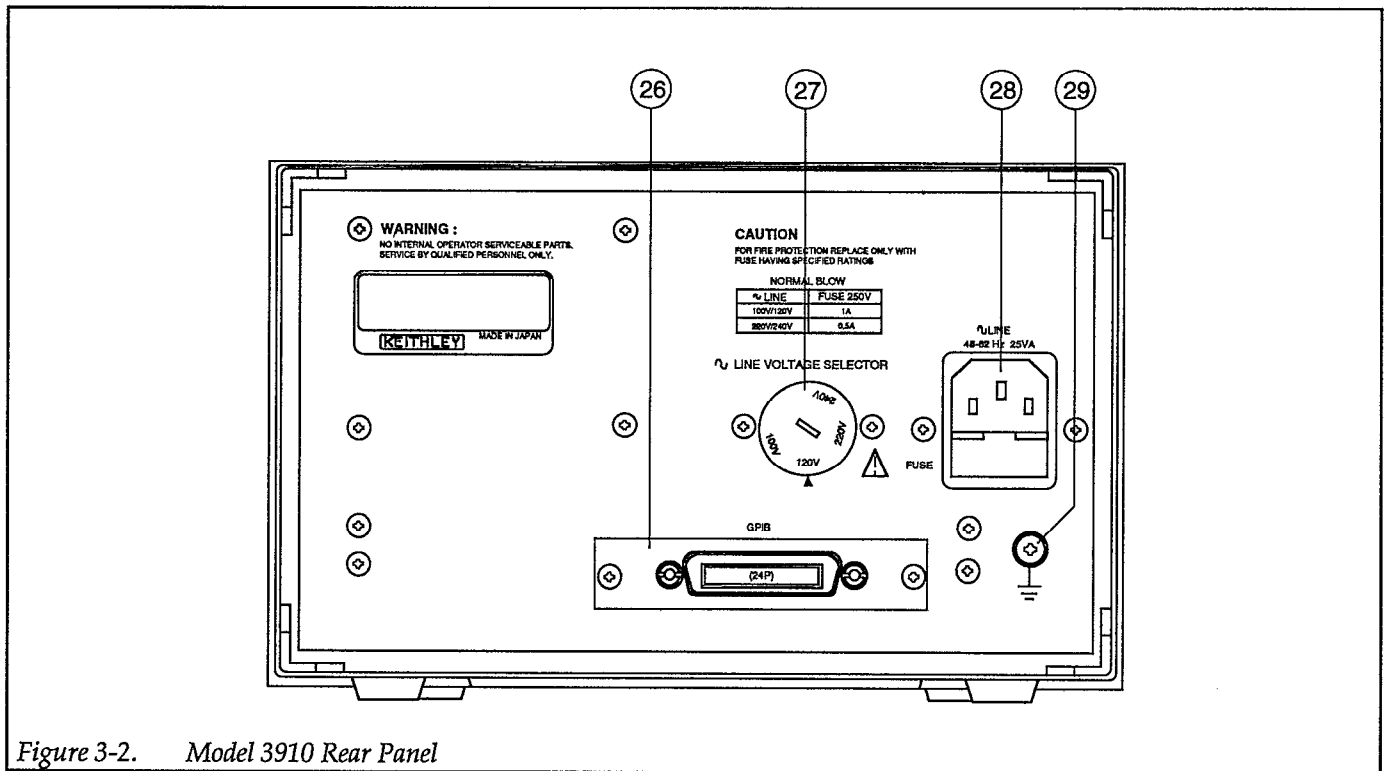

Figure 3-2. Model 3910 Rear Panel

26 GPIB (*General Purpose Interface Bus (option)*)

This connector is the 24-pin connector used to connect the Model 3911 option of the Model 3910 to the GPIB (IEEE-488 bus). Shielded GPIB cables, such as the Model 7007, are recommended for bus connections. The GPIB address is set by first selecting the GPIB display. Rotate the MODIFY knob UP (clockwise) to increase or DOWN (counter-clockwise) to decrease the GPIB address.

27 LINE Voltage Selector (*Supply voltage switch*)

This switch sets the Model 3910 for the correct line voltage. Using a flat-blade screwdriver, set the switch in the proper position for the supply voltage in your area.

WARNING

To avoid a shock hazard, disconnect the line cord before changing the switch position.

CAUTION

Operating the Model 3910 on an incorrect line voltage may result in instrument damage.

28 LINE (*Power Input Connector*)

The LINE connector is used to connect the instrument to AC power.

WARNING

To avoid the possibility of electric shock, connect the Model 3910 to grounded AC outlet using the supplied 3-wire power cord or the equivalent.

29  (*Grounding Terminal*)

The grounding terminal is connected to the chassis of the Model 3910. To prevent interference and for safety, be sure to ground this terminal.

WARNING

If the Model 3910 is connected to an ungrounded AC outlet, connect the grounding terminal to safety earth ground using #18AWG minimum wire before use to avoid the possibility of electric shock.

3.3 INPUT AND OUTPUT CONNECTIONS

3.3.1 Input Connection

One signal can be applied to the BNC connector of the Model 3910. The specification of that input signal is given below.

CAUTION

Be careful not to exceed the maximum allowable input voltages, or instrument damage may occur.

Logic Input

The logic input is TRIG IN (external trigger input).

Input name:	TRIG IN (External trigger input) external trigger during TRIG, GATE operation
Input voltage:	TTL level
Allowable input voltage:	0V to +5.5V
Circuit:	See Figure 3-3, Logic Input Circuit

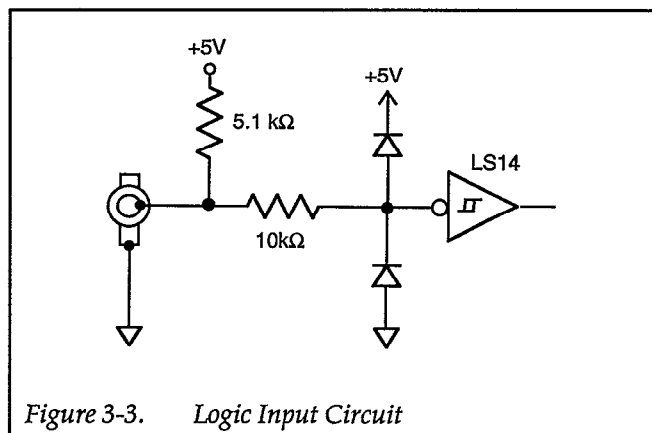

Figure 3-3. Logic Input Circuit

3.3.2 Output Connections

Two output signals are available from the BNC connectors of the Model 3910. The specifications of the output signals are given below.

CAUTION

Be careful not to connect an external signal to an output connector, or instrument damage may occur.

Analog Output

The analog output is FCTN OUT (main waveform output)

Output name:	FCTN OUT (Main Waveform Output)
Maximum output voltage:	20Vp-p/open, 10Vp-p/50Ω
Output impedance:	50Ω ±2%
Recommended Impedance:	50Ω
Short circuit protection Circuit:	See Figure 3-4, Output Circuit

Analog Output Considerations

The FCTN OUT (main waveform output) impedance is 50Ω. To maintain maximum amplitude across the entire bandwidth, and for maximum square-wave quality, use a 50Ω cable for connections, and terminate the opposite end of the cable with a 50Ω impedance. Note that the Model 3910 displays voltage amplitude for open circuit conditions. The actual output voltage with a 50Ω termination is about half that for no-load conditions.

Logic Output

The logic output is SYNC OUT (synchronous output).

Output name:	SYNC OUT
Output voltage:	TTL level
Circuit:	See Figure 3-4, Output Circuit

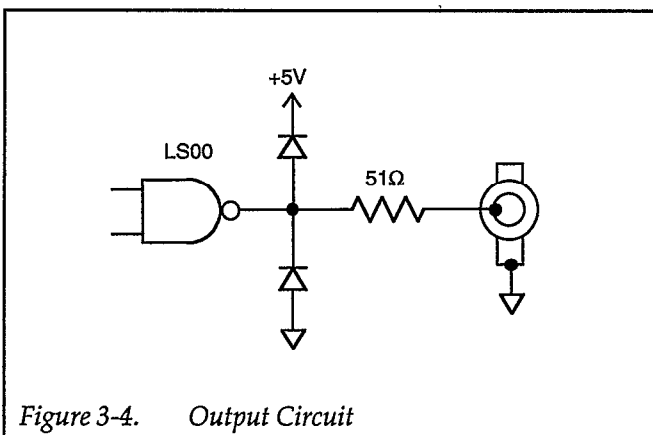

Figure 3-4. Output Circuit

Logic Output Considerations

The SYNC OUT (synchronous output) is driven by a 74LS type logic IC. The maximum load is about 25kΩ. Be careful not to connect a load that exceeds the drive capability of this type of TTL IC. Also, do not use excessively long connecting cables, as the resulting capacitance may have detrimental effects on the output signals.

The SYNC OUT impedance is matched at 50Ω at higher frequencies. Relatively good waveforms will be obtained if 50Ω coaxial cables are used; however, cables connected to this output must not be terminated with a 50Ω impedance.

3.4 STARTUP

1. Check that the supply voltage switch is set at the proper position for the supply voltage. The allowable supply voltage range is ±10% of the voltage at which the supply voltage is set.

CAUTION

Operating the Model 3910 in an incorrect line voltage may result in damage to the unit.

2. Make sure that the power is off, then plug the supplied power cable firmly into the LINE connector on the rear panel of the Model 3910. Insert the plug into a grounded AC power receptacle.

WARNING

To avoid the possibility of electric shock, use only grounded AC receptacles for power connections.

Turn on Model 3910 power by pushing the front panel POWER switch. The power is on when the POWER switch button is up; power is off when the POWER switch is down. When the power is on, the Model 3910 will begin normal operation, and the LED display will be on.

3. When the power is first turned on, the Model 3910 will return to the previous settings effective prior to power-off, and the unit will display the main parameters.

If the previous settings were not stored correctly, the error code "ERR3" will be displayed. In this case, if the CLEAR key is pushed, the machine goes to the initial reset state and can be used normally, but the

settings prior to turning off the power are lost. This situation occurs when the backup battery used to maintain memory is drained and the stored data cannot be maintained or if the power is cut off while the machine is being set. Fully charged batteries can retain memory for approximately 30 days. This time period, however, varies slightly with ambient temperature and from one battery to another.

4. The backup batteries may be discharged when the Model 3910 is used for the first time after being purchased. If "ERR 3" is displayed during initial operation, replace the batteries using the information provided in the service manual.
5. The FCTN OUT ON/OFF (function output) state is not saved. The FCTN OUT ON/OFF setting depends on the setting of the internal short plug. The factory default setting at power-on is function output on. Consult the service manual for details on setting the internal short plug.
6. If, at power on, the Model 3910 does not enter the mode with settings that were effective immediately before previous power-off (or the preset operating modes), or if the main display does not appear, contact your Keithley representative or the factory to determine the correct course of action.

NOTES:

1. Wait at least five seconds before turning on the Model 3910 after turning it off or it may not operate normally.
2. For precise measurement applications, allow the Model 3910 to warm up for at least 30 minutes to allow internal circuits to stabilize.

3.5 OPERATING PROCEDURES

3.5.1 Error Codes

When an error occurs, the Model 3910 displays an error code on the left side of the numerical display.

Displayed error codes and their meanings are summarized below.

ERR1 (ROM error)

- Abnormality in internal ROM of the machine.

ERR2 (RAM error)

- Abnormality in internal RAM of the machine.

ERR3 (Memory backup error)

- Battery backup operation failure.

When "ERR1" and "ERR2" occur, try to turn the power on again several times. If the error is still displayed, it is probably a breakdown. Contact your Keithley representative or the factory to determine the correct course of action.

When "ERR3" is displayed, replace the batteries inside with new ones. Refer to the service manual for replacement information.

If the CLEAR key is pressed when "ERR3" is displayed, the machine will be set to its default settings, and will then go into the operating state, where it can be used normally. However, the settings prior to turning off the power will be erased.

3.5.2 Frequency Setting

The frequency setting is used to set the cycles per second of the waveform selected. To change the frequency setting, first ensure that the frequency display has been selected. To select the frequency display, depress the DISPLAY SELECT button so that the LED indicator is lit next to MHz on the lower left of the display.

Once this action has been performed the Model 3910 can now have the frequency set. To move the cursor to the position you wish to change, just use the ◀ key or the ▶ key. To change the frequency setting, turn the MODIFY knob UP (clockwise) to increase the setting or DOWN (counter-clockwise) to decrease the setting.

The allowed frequency range for the sine and square waves (with 50% duty cycle) is from 0.1mHz to 1MHz; for other waveforms, the upper limit is 100kHz for good quality waveforms. Although waveform quality will be of reduced quality, oscillations up to 1MHz can be set for triangle (∇), rising sawtooth (\surd), falling sawtooth (\searrow), and variable duty square wave (\square).

3.5.3 Output Amplitude

The amplitude setting establishes the output voltage from the FCTN OUT BNC jack. The amplitude range display will display only the maximum possible output value in the current setting.

To accurately set the output amplitude, first set the desired range using the amplitude range keys. Then rotate the AMPTD knob to fine tune the output. The output value can be measured at the FCTN OUT BNC jack with a voltmeter or by using an oscilloscope. However, take note of the frequency characteristics of the voltmeter.

Amplitude setting can be performed by using both the AMPTD knob and the amplitude range keys. The allowed amplitude range is 2mVp-p to 20Vp-p.

When the DC offset is 0V, the allowed amplitude range is 2mVp-p to 20Vp-p. If, however, the DC offset is not 0V, the sum of the AC amplitude setting/2 and the DC offset must not exceed the AC amplitude setting.

The variable range of the AMPTD knob is 20dB.

The AMPTD knob can be used only on AC waveforms; use the DC OFFSET knob to set the DC output voltage of the DC waveform. When the DC waveform is selected, you can still set the amplitude range by using the amplitude range keys.

3.5.4 DC Offset

Pressing the DC OFFSET key selects whether or not DC offset is added to the waveform. When the LED in the center of the key is lit the DC offset is active. The current DC offset setting cannot be observed from the Model 3910 display. The DC offset setting should be made using a voltmeter or an oscilloscope.





To modify the DC offset, rotate the +/- offset value adjustment knob directly below the DC OFFSET key clockwise to increase the setting and counter-clockwise to decrease the setting.

Using DC as a mode, the offset voltage is the voltage of the value that appears at the output jack. Valid offset values are within the range of +10V to -10V.

For all AC waveforms, the DC offset is added to the average value of the peak-to-peak amplitude of the AC waveform. When adding DC offset to the output waveform, set them so that the sum does not exceed that of your AMPTD (amplitude range display). To prevent errors from occurring while programming amplitude-offset combinations, first set the offset to 0V, change the AMPTD setting, then set the offset to the desired value. Settings that exceed the range of the AMPTD are possible, but the waveform will be distorted or clipped. Check the waveform with an oscilloscope.

3.5.5 Waveform Selection, Square-Wave Duty Cycle, and Synchronous Output

Waveform Selection

Pressing the FCTN key advances the present waveform function on the upper right of the front panel. Available waveforms include: sine () , triangle () , square () , rising sawtooth () , and falling sawtooth () .

For all AC waveforms, the p-p value of the amplitude will remain unchanged when you change the waveform.

Square-Wave Duty Cycle

The duty cycle is the ratio of the time period of the waveform high-level duration to the time period of one complete cycle of the waveform expressed as a percentage. For example, assume a 10kHz square wave has a time period of 100μsec. If the high portion of the waveform has a period of 30μsec, the duty cycle is $30/100 \times 100 = 30\%$.

Two square-waveform duty cycles are available: one with the duty cycle fixed at 50% and the second mode with a variable duty cycle. The duty cycle applies only to the square-wave function. When the Model 3910 is in the variable duty-cycle mode, the upper frequency limit is 100kHz and the maximum jitter is 150ns.

To change the duty cycle, press the DUTY VAR FXD, VAR key. If the LED is lit in the center of the key the vari-

able duty range has been selected. To modify the variable duty cycle, turn the (variable duty) knob directly below the DUTY VAR key. The variable range of duty ratio is between 5% and 95% for frequencies up to 10kHz. For frequencies up to 100 kHz, the variable range is between 10% and 90%. It can actually be set until the point where the waveform is extinguished, but the waveform may become unstable. To select the fixed 50% duty cycle mode, press the DUTY VAR FXD,VAR key so that the LED in the center of the key is no longer lit.

Note that the duty cycle setting also changes the duty cycle of the sync out signal.

To extend the duty cycle range, use the trigger oscillation mode and one square waveform cycle. Refer to paragraph 3.5.6 for details on setting the oscillation mode.

Synchronous Output

Figure 3-5 illustrates the phase relationships between the FCTN OUT waveform and SYNC OUT (synchronous output). Note that as the frequency increases, a substan-

tial phase differential will result between the waveform output and the synchronous output signals.

3.5.6 Oscillation Mode

Oscillation Mode Selection

The oscillation mode setting is selected by the MODE switch on the right side of the front panel. The present oscillation mode is displayed by the lit LED next to the selected mode. Each time the mode key is depressed the mode is advanced by one. Available oscillation modes include CONT (continuous), BURST, TRIG (trigger), and GATE. In addition, it is also possible to select DC for a continuous output of direct current voltage.

CONT (continuous mode)

When the continuous mode is selected, the instrument generates the selected waveform continuously. Triggering is not required, and the selected burst cycle and internal rate parameters have no effect on the output waveform.

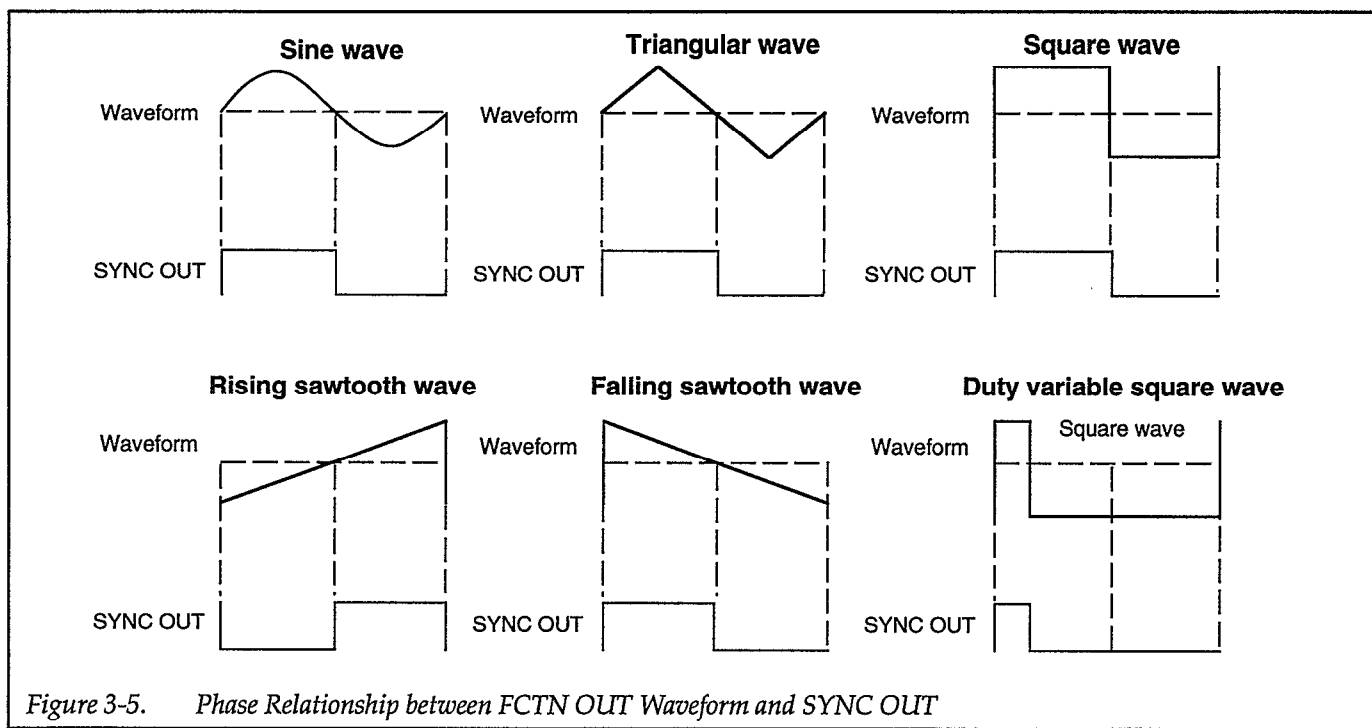

Figure 3-5. Phase Relationship between FCTN OUT Waveform and SYNC OUT

BURST

In the burst mode, the instrument generates the selected waveform for the specified mark wave number and space wave number. No trigger signal is required to initiate the waveforms. The mark wave number and space wave number can be set by first pressing the DISPLAY SELECT button so that the LED is lit next to GPIB on the upper left of the display. When the LED is lit next to GPIB, the mark wave number and space wave number can be found on the right side of the display. Then by using the ◀ and ▶ keys advance the cursor to either mark wave number or space wave number. Turn the MODIFY knob UP (clockwise) to increase the wave number or DOWN (counter-clockwise) to decrease the wave number. The phase where oscillation starts can be set in 0.1° from $+360.0^\circ$ to -360.0° .

TRIG (trigger)

In the trigger mode, the instrument generates the selected waveform for the number of specified mark wave numbers each time a trigger comes from the outside. The trigger signal is effective only while oscillation is stopped, and trigger signals prior to when the oscillation finishes are ignored. To set the mark wave number first press the DISPLAY SELECT button so that the LED is lit next to GPIB on the upper left of the display. When the LED is lit next to GPIB, the mark wave number can be found on the right side of the display. Then use the ◀ and ▶ keys to advance the cursor to the mark wave number. Turn the MODIFY knob UP (clockwise) to increase the mark wave number or DOWN (counter-clockwise) to de-

crease the mark wave number. The phase where oscillation starts can be set in 0.1° units from $+360.0^\circ$ to -360.0° .

Triggering is performed by either using the TRIG IN (external trigger) BNC jack or by pressing the MAN (manual) key on the front of the unit.

Figure 3-6 shows the relationship between the trigger signal and oscillation in TRIG mode.

GATE

In the GATE mode, the unit generates oscillations as long as the gate signal (trigger signal) is on. When the gate signal turns off, the Model 3910 will always stop oscillating at the end of one complete cycle even if the gate signal turns off at the mid point of a cycle. Thus, the Model 3910 always provides integral cycles of oscillation. The phase where the oscillation starts can be set in 0.1° units from $+360.0^\circ$ to -360.0° .

Triggering is performed by either using the TRIG IN (external trigger) BNC jack or by pressing the MAN (manual) key on the front of the unit.

Figure 3-7 demonstrates how the output waveform always completes the current cycle when the gate signal turns off.

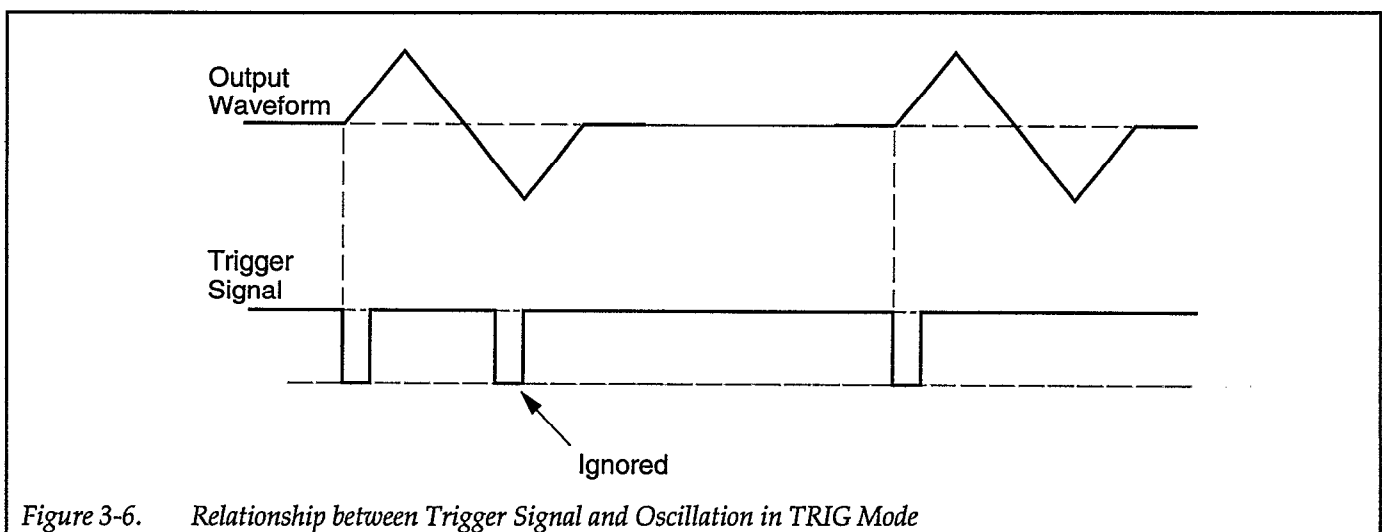

Figure 3-6. Relationship between Trigger Signal and Oscillation in TRIG Mode

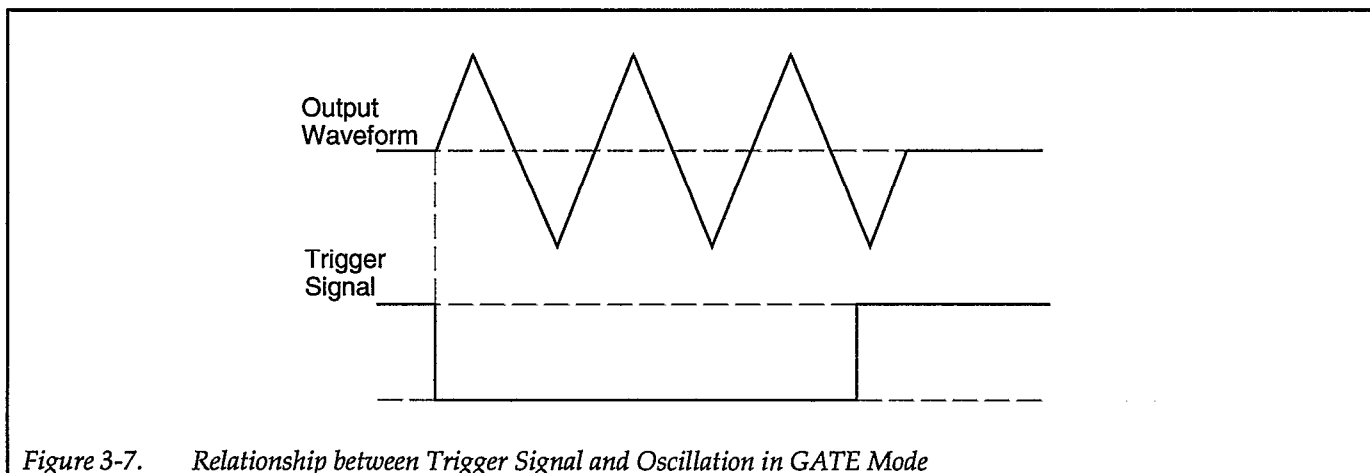

Figure 3-7. Relationship between Trigger Signal and Oscillation in GATE Mode

NOTE

In the trigger or gate oscillation modes, if the next trigger is applied at about the same time the unit terminates oscillation, oscillation may become unstable. In this situation, temporarily change the oscillation mode, then return the unit to the original mode. Oscillation will return to normal.

play. When the LED is lit next to GPIB, the start/stop phase setting can be found in the center of the display. To change the current start/stop phase setting, move the cursor to the start/stop phase by using the ◀ and ▶ cursor keys. Then set the start/stop phase by turning the MODIFY knob UP (clockwise) to increase the setting or DOWN (counter-clockwise) to decrease the setting. The allowed range for the start/stop phase parameter is -360.0° to $+360.0^\circ$ with 0.1° resolution.

DC Mode

DC is a mode in which oscillation from the synthesizer is stopped. In this mode only a constant voltage is output. When the MODE is set to DC, DC OFFSET ON/OFF must be on (LED lit in center of DC OFFSET ON/OFF key). To alter the output voltage, turn the +/- knob, directly below the DC OFFSET ON/OFF switch, clockwise to increase the voltage or counter-clockwise to decrease the voltage. The maximum voltage of the DC output is $\pm 10V$, and current is up to 100mA. Short circuit protection on the output has been installed.

The definitions of each waveform and its phase are shown in Figure 3-8.

The Model 3910 generates square waves with a fixed 50% duty cycle by processing sine waves with a zero-crossing comparator that has hysteresis. The level of the generated square wave, therefore, alternates high and low at approximately 0° , $\pm 180^\circ$, and $\pm 360^\circ$ (within about $\pm 2.3^\circ$) depending on the past value of the phase. Thus, to set the square-wave start/stop level high, set the phase to 90° . Similarly, the phase should be set to -90° to set the square-wave start/stop level low.

3.5.7 Trigger Parameters

Start/Stop Phase

The start/stop phase setting is the starting and finishing position for waveform cycles. To set start/stop phase press the DISPLAY SELECT button so that the LED indicator light is lit next to GPIB in the upper left of the dis-

The Model 3910 also generates the synchronous output for the sine, triangle, and sawtooth waves by passing each waveform through a zero-crossing comparator that has hysteresis. As a result, the synchronous output level changes at the same points as the square wave when the phase is approximately 0° , $\pm 180^\circ$, or $\pm 360^\circ$ for the sine or triangle waves, or about $\pm 180^\circ$ with the sawtooth wave.

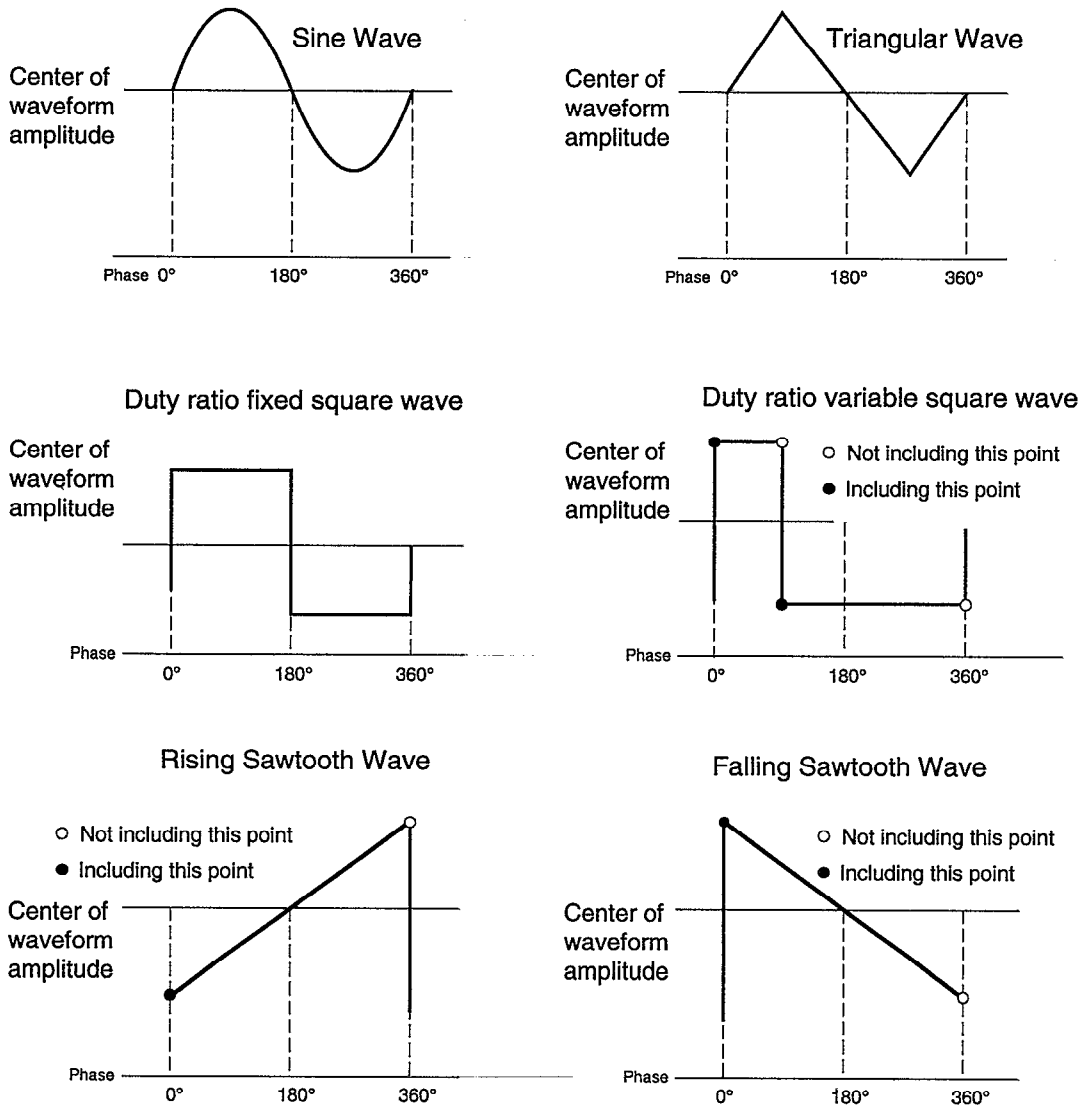

Figure 3-8. Definition of Phase of each Waveform

Mark Wave Number Setting

The mark wave setting is used to set the number of oscillation cycles the unit generates each time it is triggered in the BURST and TRIG oscillation modes. To set the mark wave number, press the DISPLAY SELECT button so that the LED is lit next to GPIB on the upper left of the display. When the LED is lit next to GPIB, the mark wave number setting can be found on the right side of the display. To change the current mark wave number setting, move the cursor using the ◀ and ▶ cursor keys to the desired number. Then turn the MODIFY knob UP (clockwise) to increase the setting or DOWN (counter-clockwise) to decrease the setting. The allowable range for the mark wave number setting is 1 to 16.

Space Wave Number Setting

The space wave setting is used to set the number of non-oscillation cycles between each group of oscillation cycles in the BURST mode. To set the desired space wave number, press the DISPLAY SELECT button so that the LED is lit next to GPIB on the upper left of the display. When the LED is lit next to GPIB, the space wave number can be found on the far right side of the display. To change the current space wave number setting, move the cursor using the ◀ and ▶ cursor keys to the desired number. Then turn the MODIFY knob UP (clockwise) to increase the setting or DOWN (counter-clockwise) to decrease the setting. The allowable range for the space wave number is 1 to 16.

SECTION 4

GPIB Interface

4.1 INTRODUCTION

4.1.1 GPIB Overview

The GPIB interface is a general-purpose interface bus system recognized by the IEEE (Institute of Electrical and Electronics Engineers) in 1975 and is a method of standardizing data transfer between measuring instruments and peripherals. By building each controller and peripheral device into an interface conforming to this standard, it is possible to establish complete hardware compatibility among devices.

Up to 15 devices may be connected to a single interface bus, and data transfer is performed by three handshake lines, enabling reliable data transfer between data senders (talkers) and receivers (listeners) having differing data transfer rates.

4.1.2 Major GPIB Specifications

Overall cable length: 20m maximum
Cable lengths between devices: 4m maximum
Number of devices connectable
(including a controller): 15 maximum

Transfer method: 3-line handshake
Transfer rate: 1M bytes/sec (maximum)

Data transfer: 8-bit parallel

Signal lines:

Data Bus: 8 Lines

Control bus: 8 Lines

(including DAV, NRFD, and NDAC handshake lines and ATN, REN, IFC, SRQ, and EOI control lines)

Signal/system grounds: 8 lines

Signal logic: Negative

True (low-level): 0.8V maximum

False (high-level): 2.0V minimum

4.1.3 Bus Line Signals and Operation

The GPIB bus consists of 24 lines, including eight data lines, eight control lines, and eight signal/system ground lines.

Data Bus (DIO1 to DIO8)

DIO1 through DIO8 are data input/output lines, which are used to transfer both address and command information (the type of data present on these lines is determined by the ATN line). DIO1 is the least significant bit (LSB).

Handshake Bus (DAV, NRFD, NDAC)

These three lines are handshake lines used to ensure reliable data transfer.

DAV (DAta Valid)

This line indicates that the data on the DIO lines sent from a talker or the controller are valid.

NRFD (Not Ready For Data)

This line indicates when the listeners are ready to accept data over the data lines.

NDAC (Not Data Accepted)

This line indicates the acceptance of data by listeners.

Control Bus (ATN, REN, IFC, SRQ, EOI)

ATN (ATeNtion)

This line is an output line from the controller, and it indicates whether the information on the data bus is to be interpreted as data or commands.

REN (Remote ENable)

This output line from the controller switches devices between remote control and local control.

IFC (InterFace Clear)

This output line from the controller clears the interface of active talkers and listeners.

SRQ (Service ReQuest)

This control line is used by a device to request service from the controller. The controller detects this signal and usually executes a serial or parallel poll operation.

EOI (End Or Identify)

This line is used to indicate the end of a multiple-byte transfer sequence or, in conjunction with ATN, to execute a parallel poll operation.

4.1.4 GPIB Handshaking

GPIB handshaking is performed by checking the status of all listeners and inhibiting the next data transfer until all listeners have completed the reception of data, so that the slowest device on the bus can perform data transfer reliably. The handshaking operations are executed by the following handshake line logic levels:

NRFD=High level: All listeners are ready for accepting data.

DAV=Low level: A talker has valid data on the data bus.

NDAC=High level: All listeners have completed data reception.

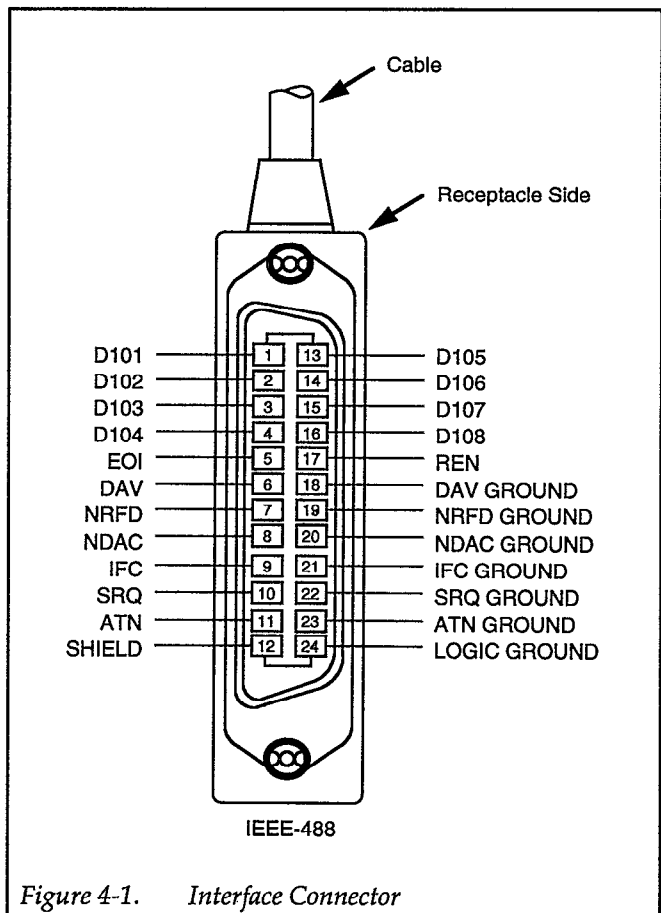

Figure 4-1. Interface Connector

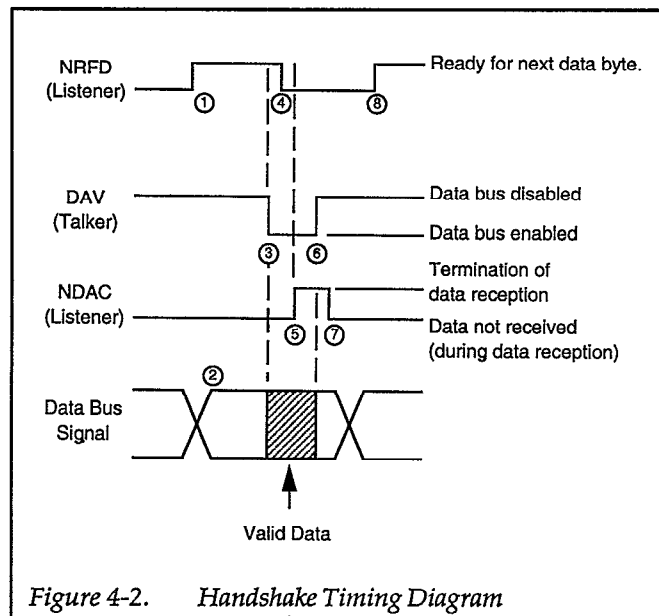

Figure 4-2. Handshake Timing Diagram

The handshaking timing diagram is in Figure 4-2. The various timing points indicate the following:

- ① Indicates that all listeners are waiting for data.
- ② The talker places the data byte to be sent on the data lines. Output may have already occurred.
- ③ The talker checks NRFD, and, if high, DAV is set low to indicate to the listener that the data is valid.
- ④ When DAV goes low, the listener reads data, and NRFD is set low, indicating to the talker that data processing is in progress. Each listener sets NDAC high at the completion of data input. The NDAC logic level is the result of ORing the NDAC signals from each listener.
- ⑤ When all listeners have completed receiving data, NDAC goes high, indicating to the talker that data reception has been completed.
- ⑥ The talker sets DAV high, indicating to the listener that data on the bus is no longer valid.
- ⑦ The listener checks to see whether DAV is high and sets NDAC low, completing the handshake.
- ⑧ Indicates that all listeners have completed data input, and the bus is ready to transfer the next data byte.

4.1.5 Data Transfer Example

Figure 4-3 shows a data transfer example using the three-line handshake process. In this example, the character string "ABC" is sent, followed by the <CR> <LF> delimiter.

4.1.6 Basic Talker Functions

- Only one talker may exist on the GPIB at a time.
- Data is sent to the listeners when the controller ATN line is high (false).
- Source handshaking is performed automatically.
- A service request (SRQ) is sent to the controller by other devices.
- The talker function is available with both the local and remote modes.
- The talker function is canceled by any of the following:
 - When the talk address of another device is received.
 - When the device is addressed as a listener.
 - When the untalk (UNT) command is received.
 - When the interface clear (IFC) command is received.

4.1.7 Basic Listener Functions

- Two or more listeners may exist on the GPIB at any time.
- Data is received from a talker when the controller ATN signal is high.
- The acceptor handshake is performed automatically.
- The listener function is canceled by any of the following:
 - When the device is addressed to talk.
 - When the unlisten (UNL) command is received.
 - When the IFC command is received.

4.1.8 Basic Controller Functions

- Only one controller can be active on the GPIB.
- The controller sets the ATN signal to low to address devices to listen and talk, and to transmit commands such as DCL.
- The controller sends single-line commands such as IFC and REN.

4.1.9 Multi-line Interface Messages

A multi-line interface message is sent over the data lines with ATN set low. Table 4-1 summarizes these messages.

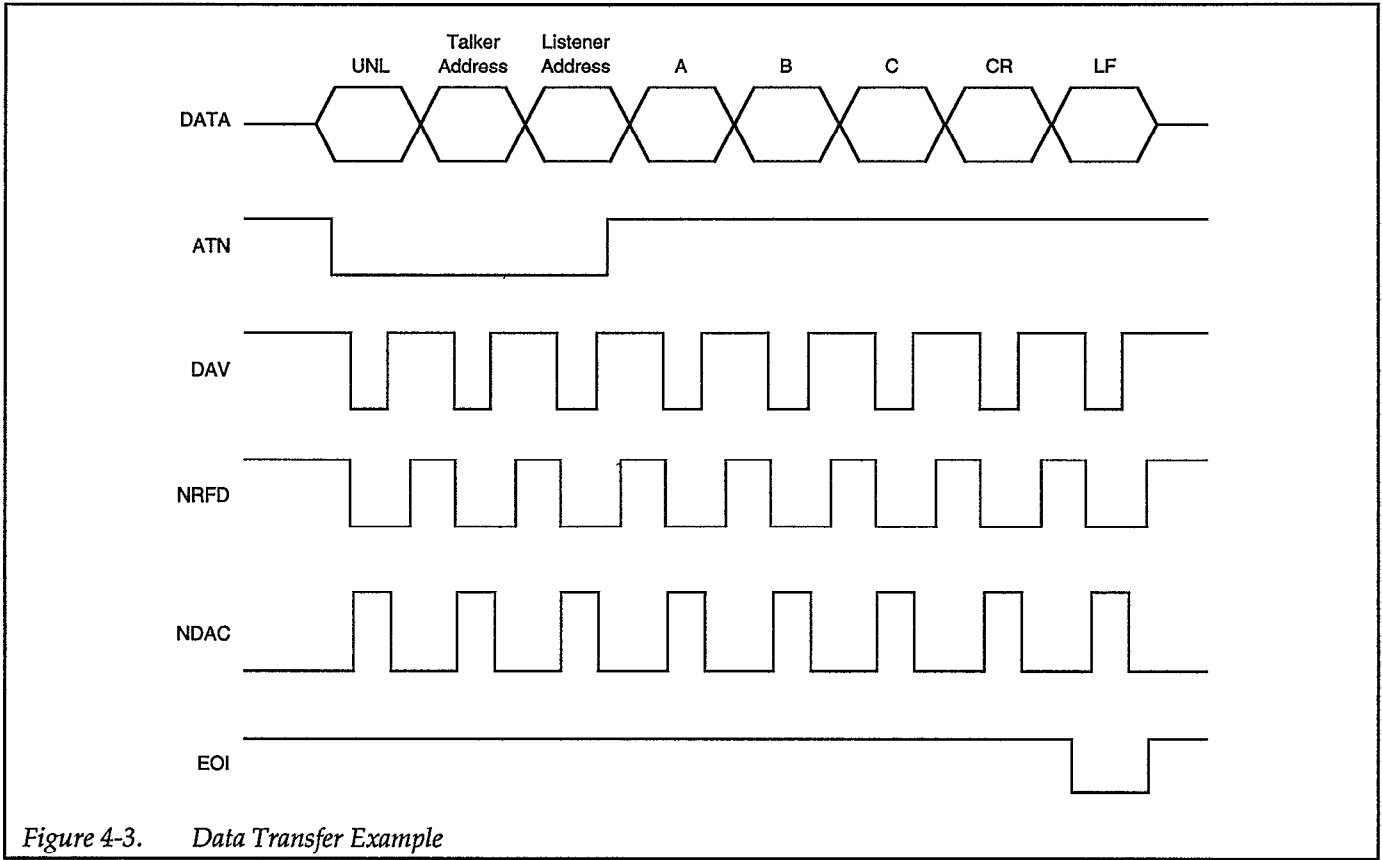

Figure 4-3. Data Transfer Example

4.2 OVERVIEW OF MODEL 3910 GPIB INTERFACE

4.2.1 Introduction

The Model 3910 GPIB interface has a wide variety of interfacing functions. These functions allow remote setting of most of the parameters which can be set from the front panel. Items that cannot be controlled from GPIB are AMPTD, amplitude setting; DC offset, added quantity setting; and DUTY VAR, duty ratio setting; which correspond to regulators other than the MODIFY dial on the panel. The interface can also transfer setting data and conditions to an external device, enabling the user to easily configure a sophisticated automatic measurement system.

Setting data and conditions are sent to the controller as character strings in ASCII format.

4.2.2 Specifications

Interface Functions

Table 4-2 shows the interface functions of the Model 3910.

Table 4-2. Interface Functions

Function	Subset	Explanation
Source Handshake	SH1	Sending handshake all functions
Acceptor Handshake	AH1	Receiving handshake all functions
Talker	T6	Basic talker, serial poll, talker cancel by MLA
Listener	L4	Basic listener function, listener cancel by MLA
Service Request	SR1	Service request all functions
Remote/Local	RL1	Remote local all functions
Parallel Poll	PP0	No parallel poll functions
Device Clear	DC1	Device clear all functions
Device Trigger	DT0	No device trigger functions
Controller	C0	No controller functions

Bus Driver

Table 4-3 gives the bus driver specifications.

Table 4-3. Bus Driver Specifications

DIO1 to DIO8 NDAC, NRFD, SRQ	Open Collector
DAV EOI	Three-state Three-state

Codes

Codes which can be received by the Model 3910 in listener mode are in 7-bit ASCII format (bit 7 is ignored). Codes can be sent using either lower-case or upper-case letters. In either case, codes are interpreted and executed identically. The space (20H), tab (09H), and semicolon ";" (3BH) characters are ignored.

Talker (inquiry) mode transmission codes are also in 7-bit ASCII format. All letter characters are sent as upper-case letters.

GPIB Primary Address

The GPIB address of the Model 3910 is set as follows:

On the front panel press the DISPLAY SELECT button so that the red indicator light is on next to GPIB on the upper left of the display. Then move the cursor by using the cursor arrow keys so that the cursor is now in the GPIB display. Set the GPIB address by rotating the MODIFY knob UP (clockwise) to increase the value and DOWN (counter-clockwise) to decrease the value. Set values are stored in battery backed-up memory when the power is turned off.

Delimiter

The Model 3910 recognizes <CR>, <LF>, or <EOI> in any combination as a delimiter for receiving code strings in the listener mode.

The delimiter used when sending a response in the talker mode is set from the front panel with the GPIB key. Only <CR> or <CR><LF> can be selected as an output delimiter, and EOI is sent simultaneously.

Response to Interface Messages

Table 4-4 summarizes Model 3910 responses to interface messages.

Table 4-4. Response to Interface Messages

IFC	Initializes GPIB interface. Releases specified listener and talker modes.
DCL and SDC	Clears GPIB input/output buffer. Clears error status. Releases SRQ transmission and resets SRQ causes (unit's operating modes do not change).
LLO	Disables front panel (LOCAL) key.
GTL	Goes into local mode (front panel programming enabled).

Program Codes

Program codes used for the various settings of the Model 3910 are temporarily stored in the input buffer of the machine. When a delimiter is received, they are interpreted and executed in the order received. The input buffer can store up to 14 characters (14 bytes). Note that space, tab, and semicolons are not stored in the input buffer.

When more than 14 program code characters are received, the input buffer overflows. When an overflow occurs, the input buffer is cleared, and program codes stored in the buffer are not executed.

In addition, the input buffer is cleared, and subsequent program codes are not executed when an illegal header or parameter is found during the interpretation of a program code.

When interpretation and execution are completed, the input buffer is cleared, and the unit is ready to receive the next program code.

As shown in Figure 4-4, program codes consists of a header and a parameter. More than one program code can be sent at a time, up to a maximum of 14 characters. Multiple program codes can be separated by a space or semicolon (;) to improve readability.

There are two general types of program codes: parameter-setting messages and inquiry messages. Parameter-setting messages are used for setting parameters or for sending operating instructions. Inquiry messages are used for requesting state and parameter setting information from the instrument.

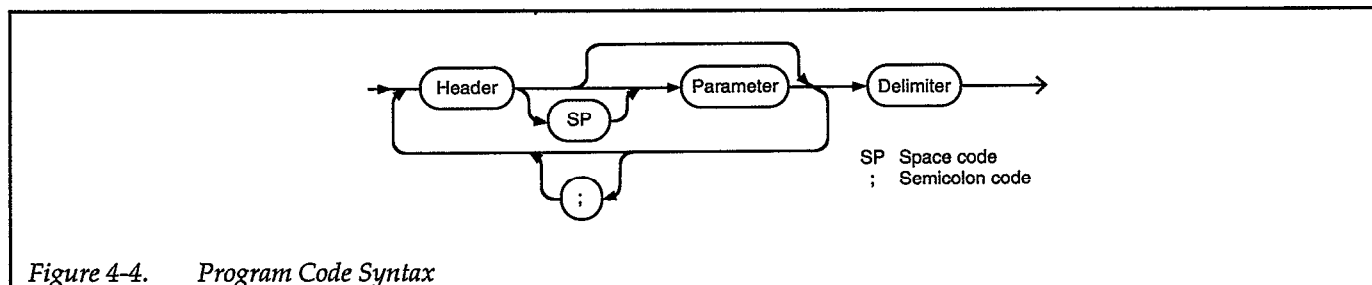

Figure 4-4. Program Code Syntax

Parameter Setting Messages

The format of a basic setting message is shown below. In this example, the start/stop phase is set to -120.0° , and the waveform is set to a triangle wave.

P = 1200 ; W 1
 a b c d a c

- a: Indicates the single letter alphabetic character header. Either upper-case or lower-case letters can be used.
- b: Indicates polarity and can only be used with start/stop phase. When polarity is omitted, the plus sign (+) is assumed.
- c: Indicates the value of the parameter. If the range of the parameter is exceeded, program codes thereafter are ignored.
- d: Indicates the semicolon used to separate program codes for readability. There is no limit on the number of semicolons, and the semicolon can be omitted. The semicolon is also ignored and is not stored in the GPIB input buffer.

Numeric Format of Parameter-setting Messages

NR1 Format

In the NR1 format, numeric values are specified as integers. No decimal point is used in this format. The decimal point is assumed to be at the end of the last character.

When setting frequency
 DDDDDDDDDDD (maximum 11 digits)

When setting phase
 \pm DDDD (maximum 4 digits)

For other settings
 D or DD

Inquiry Messages

There are no inquiry messages in this instrument. When the machine is specified as a talker, only a handshake is performed, and the response is only $\langle CR \rangle \langle LF \rangle + \langle EOI \rangle$.

Service Request

The Model 3910 can request service from the controller via the SRQ line under the following conditions:

- FCTN OUT ON/OFF key was operated.
- Out-of-standard program codes, headers were received.

When the controller detects SRQ and serial polling is performed, the machine sends a status byte to the controller, and the SRQ signal is set to HIGH.

The status byte can be read by serial polling. If the status byte is read, bits 2, 5, and 6 are reset to 0.

Bits in the status byte can be masked so that those particular conditions will not cause an SRQ to occur. To mask bits, set the corresponding bits to 1 by adding up the decimal bit values and sending them with the "K" program code. For instance, to disable SRQ by masking the FCTN OUT ON/OFF(4), send the command "K5" (4 + 1). When this bit is masked, an SRQ will not occur at FCTN OUT ON/OFF.

Bit 0 changes each time according to the state of FCTN OUT.

If SRQ is not masked, even in the local state, sending of SRQ is performed if a cause is generated.

“K0” is set in the initial state when power is turned on, and all SRQ causes are masked, and SRQ is not sent.

When service request is not used, “K0” is set.

4.3 MODEL 3910 PROGRAM CODES

Table 4-5. Status Byte

Bit	Description	Set (1) Condition	Reset (0) Condition
(MSB) 7	0	Always 0 (not used)	Always 0 (not used)
6	RQS	<ul style="list-style-type: none"> When SRQ is issued. 	<ul style="list-style-type: none"> When status byte output When DCL or SDC received When SRQ cause was eliminated due to SRQ mask set
5	Error (SRQ cause)	<ul style="list-style-type: none"> When out-of-standard program code or parameter was received 	<ul style="list-style-type: none"> When DCL or SDC received When status byte was output after SRQ sent
4	Not used	Always 0 (not used)	Always 0 (not used)
3	Not used	Always 0 (not used)	Always 0 (not used)
2	FCTN OUT key was operated (SRQ Cause)	<ul style="list-style-type: none"> When FCTN OUT ON/OFF key was operated 	<ul style="list-style-type: none"> When DCL or SDC received When status byte was output after SRQ sent
1	Not used	Always 0 (not used)	Always 0 (not used)
(LSB) 0	State of FCTN OUT	<ul style="list-style-type: none"> FCTN OUT ON 	<ul style="list-style-type: none"> FCTN OUT OFF

Table 4-6. Model 3910 Main Parameter Setting Messages

Function	Program Code		Operation and Setting Range
	Header	Parameter	
<u>A</u> MPLITUDE	A	NR1	AMPTD range settings Range: 0 (-20Vp-p) 1 (-2Vp-p) 2 (-0.2Vp-p) 3 (-0.02Vp-p) Ex: A2 (-0.2Vp-p)
<u>C</u> YCLE	C	NR1	MARK wave number settings Range: 1-16 Ex: C2 (MARK wave number 2 wave setting when BURST, TRIG)
<u>D</u> C	D	NR1	DC OFFSET ON/OFF settings Range: 0 (off) 1 (on) Ex: D1 (DC OFFSET on)
<u>F</u> REQUENCY	F	NR1	Frequency settings (frequency: Hz) Range: 1 (0.1mHz) to 10000000000(1MHz) Ex: F10000000
<u>M</u> ASK	K	NR1	SRQ mask settings Range: 0 (SRQ off) 4 (FCTN OUT ON/OFF) 32 (error) 36 (FCTN OUT ON/OFF and error) Ex: K4 (SRQ sent when FCTN OUT ON/OFF key is operated)
<u>M</u> ODE	M	NR1	MODE Settings Range: 0 (CONT) 1 (BURST) 2 (TRIG) 3 (GATE) 4 (DC) Ex: M0 (CONT)
<u>O</u> F FCTN OUT	O	NR1	FCTN OUT ON/OFF settings Range: 0 (off) 1 (on) Ex: O1 (on)

Model 3910 Main Parameter Setting Messages (Cont.)

Function	Program Code		Operation and Setting Range
	Header	Parameter	
START/STOP PHASE	P	NR1	Start/stop phase setting Range: -3600 (-360.0°) to +3600 (+360.0°) Ex: P-1200 (-120.0°)
SPACE	S	NR1	SPACE wave number settings Range: 1 to 16 Ex: S2 (SPACE wave number 2 wave setting when BURST)
TRIG	T	NR1	Trigger signal from GPIB Range: 0 (trigger off) 1 (trigger on) Ex: Set from T0 → T1 → T0 when trigger operated.
DUTY VAR	V	NR1	DUTY VAR on/off settings Range: 0 (off) 1 (on) Ex: V1 (on)
WAVE	W	NR1	FCTN switching Range: 0 (sine wave) 1 (triangle wave) 2 (square wave) 3 (rising sawtooth wave) 4 (falling sawtooth wave) Ex: W0 (sine wave)

4.4 TYPICAL EXECUTION TIMES

The execution times shown in Table 4-7 are the times required from the reception of the command until execution is complete.

It takes about 1msec/byte for the Model 3910 to receive a command from the GPIB.

Table 4-7. Typical Execution Times

Function	Setting Message Header	Typical Execution Time (ms)
Amplitude	A	5.6
Cycle	C	5.7
DC	D	2.3
Frequency	F	5.5
Mask	K	2.0
Mode	M	3.0
Fctn out	O	5.8
Start/Stop Phase	P	6.2
Space	S	5.8
Trig	T	2.0
Duty Var	V	2.4
Wave	W	6.4

4.5 SAMPLE PROGRAMS

This paragraph presents three sample programs to control the Model 3910 using an HP 9816 (or equivalent) personal computer as the controller. The primary address of the Model 3910 interface is assumed to be 2, and the delimiter is <CR> <LF>.

Sample program 1 allows you to type in program codes and send them to the Model 3910.

Sample program 2 sets the SRQ mask to generate an SRQ on an error condition. An illegal command option is sent, the Model 3910 is serial polled, and the serial poll byte is displayed with the error bit (B5) set.

Sample program 3 includes subroutines for sending interface messages IFC, DCL, SDC, LLO, and GTL to the Model 3910 and the subroutines to set REN true or false.

Sample Program 1

```

10  OUTPUT KBD;CHR$(255);CHR$(75);      ! Clear screen
20  CLEAR 702                            ! Clear GPIB
30  REMOTE 702                            ! Set for GPIB communication
40  DIM A$[50]                            ! Dimension string for input
50  LINPUT "Command String:",A$          ! Prompt for and get command
60  IF LEN(A$)=0 THEN 100                 ! Check for null
70  OUTPUT 702;A$                         ! Send command
80  WAIT 1                                ! Delay 1 second
90  GOTO 50                               ! Repeat
100 END

```

Sample Program 2 and Results

```

10  REMOTE 702                            ! Set for GPIB communication
20  OUTPUT 702;"K32"                      ! Program for SRQ on error
30  OUTPUT 702;"A4"                       ! Try to program invalid option
40  S=SPOLL(702)                           ! Serial poll the 3910
50  IF NOT BIT(S,5) THEN 40                ! Wait for SRQ to occur
60  PRINT "B7 B6 B5 B4 B3 B2 B1 B0"       ! Label the bit positions
70  FOR I=7 TO 0 STEP -1                  ! Loop 8 times
80  PRINT BIT(S,I);                       ! Display the bit positions
90  NEXT I
100 PRINT
110 END

```

```

B7 B6 B5 B4 B3 B2 B1 B0
0 1 1 0 0 0 0 1

```

Sample Program 3

```
10      !  
20      ! IFC  
30      ABORT 7  
40      RETURN  
50      !  
60      ! DCL  
70      CLEAR 7  
80      RETURN  
90      !  
100     ! SDC  
110     CLEAR 702  
120     RETURN  
130     !  
140     ! LLO  
150     LOCAL LOCKOUT 7  
160     RETURN  
170     !  
180     ! GTL  
190     LOCAL 702  
200     RETURN  
210     !  
220     ! REN True  
230     REMOTE 7  
240     RETURN  
250     !  
260     ! REN False  
270     LOCAL 7  
280     RETURN
```

APPENDIX A

Typical Data

INTRODUCTION

Appendix A provides the typical performance data for the Model 3910.

This instrument was thoroughly tested, inspected and

certified as meeting its published specifications when it was shipped from the factory. However, the typical data represents mean values of measurements for each Model 3910. Thus, measured performance of your Model 3910 may be different than that indicated by the typical data curves shown here.

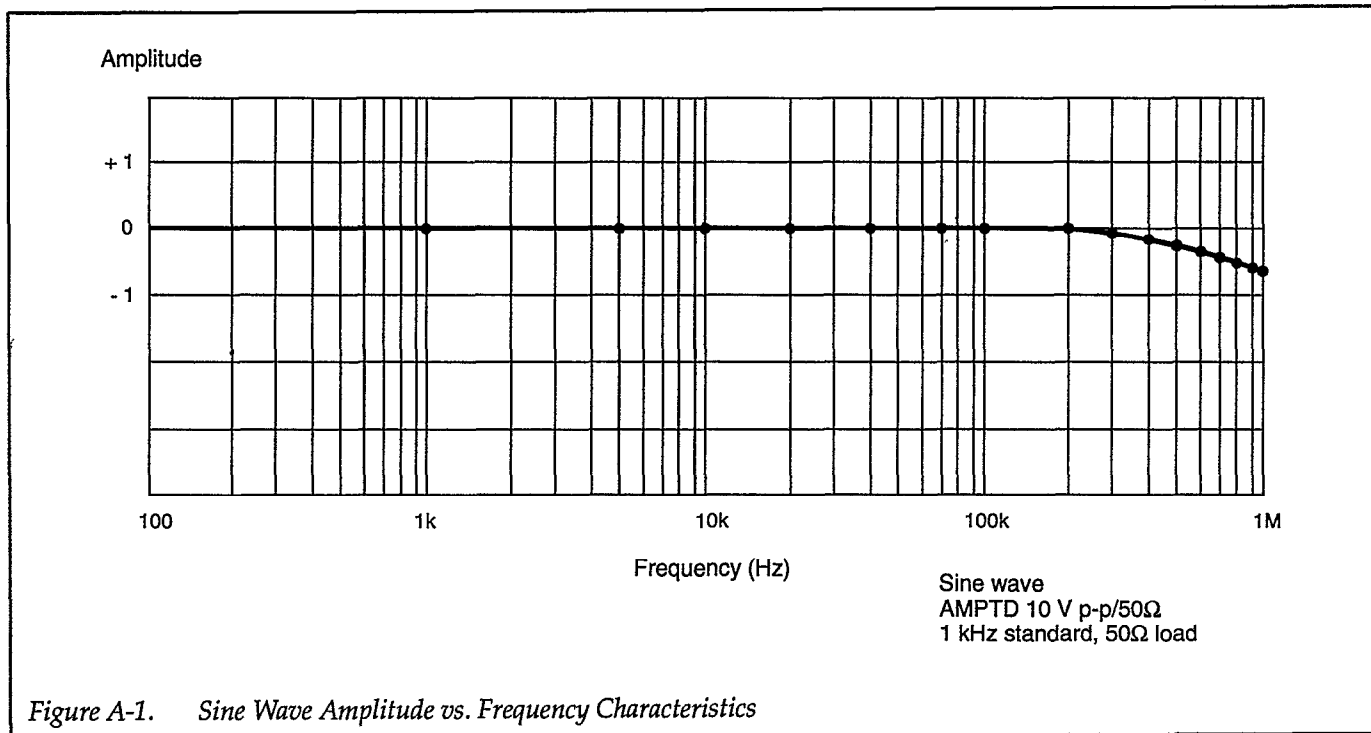

Figure A-1. Sine Wave Amplitude vs. Frequency Characteristics

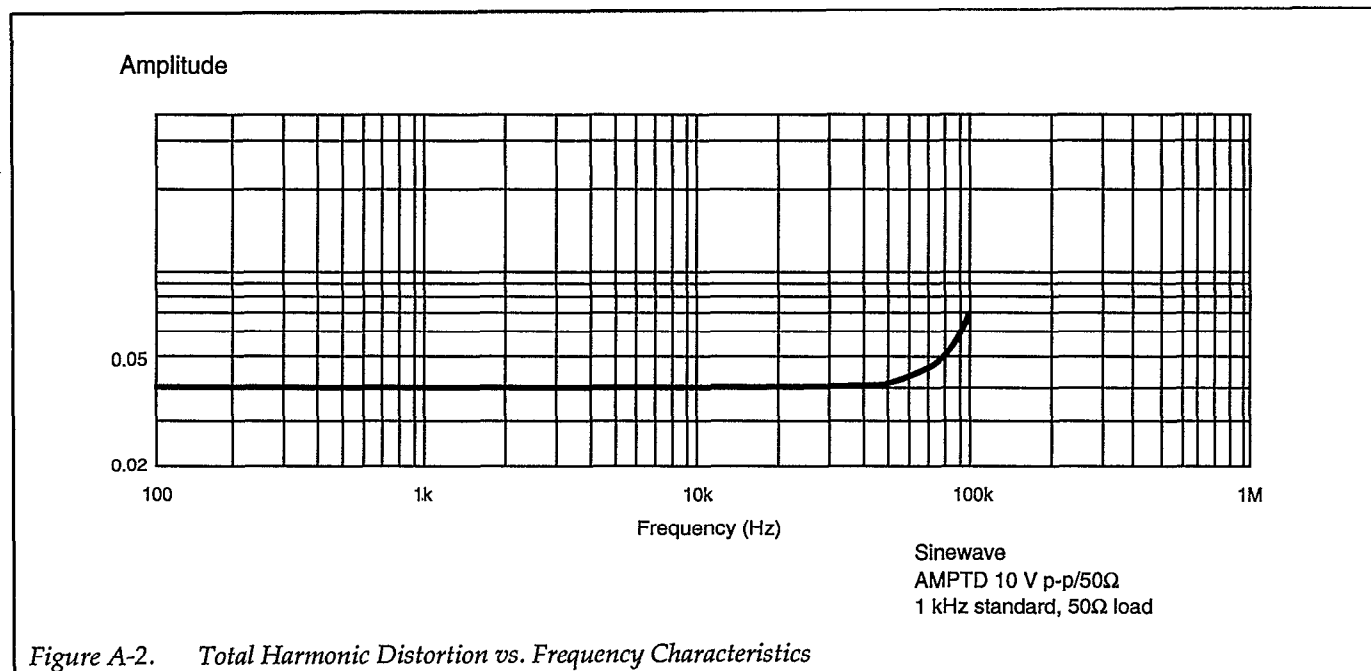

Figure A-2. Total Harmonic Distortion vs. Frequency Characteristics

APPENDIX B

Model 3910 and 3910/11 Specifications

B.1 ELECTRICAL SPECIFICATIONS

Waveforms	
DC only, , , , ,	

Oscillation Modes		
Continuous	CONT	Continuous oscillation
Burst	BURST	Continually outputs an integer number of waveform cycles followed by an integer number of gaps.
Trigger	TRIG	Upon receiving a trigger, will output an integer number of waveform cycles.
Gate	GATE	N-cycles generated while trigger signal is on (i.e. Logic Low). N is an integer.
DC	DC	Outputs a DC level.

Frequency		
Waveform and Frequency Range	, (Duty fixed)	0.1mHz to 1MHz
	, , , (Duty variable)	0.1mHz to 100kHz
Display	Maximum 11 columns, resolution 0.1mHz (constant)	
Accuracy	$\pm 30 \times 10^{-6}$ (± 30 ppm)	

Output Characteristics				
Maximum Output	AC only	20Vp-p/open, 10Vp-p/50Ω load		
	DC only	± 10 V/open, ± 5 V/50Ω load		
Amplitude Frequency Characteristics	Amplitude accuracy referenced to amplitude at 1kHz, DC offset off, 50Ω load, 10Vp-p output			
	Sine wave	± 0.1 dB @ 10kHz		
		± 1 dB, -3dB @ 1MHz		
	Triangle wave	$\pm 5\%$ @ 10kHz		
	Square wave	$\pm 5\%$ @ 10kHz		
	Rising sawtooth wave	$\pm 7\%$ @ 10kHz		
	Falling Sawtooth wave	$\pm 7\%$ @ 10kHz		
AMPTD Ranges	20Vp-p, 2Vp-p, 0.2Vp-p, 0.02Vp-p			
AMPTD Variable Adjustment	Max = 0dB, Min = -20dB			
Spectrum Purity	CONT mode, DC offset off, 50Ω load, 10Vp-p output			
	Total harmonic distortion	10Hz to 100kHz below 0.3%		
	Harmonics	100kHz to 500kHz	-45dBc typ.	
		500kHz to 1MHz	-40dBc typ.	
Spurious	1MHz	-55dBc typ.		
Square Wave Characteristics	DC offset off, 50Ω load, 10Vp-p output			
	Rise/Fall Time	120nsec typ.		
	Overshoot/Undershoot	Within 5% of output p-p value		
	Fixed duty ratio precision (in CONT mode)	1% of period @ 10kHz		
	Duty variable range	DC offset off, 50Ω load, 10Vp-p output		
		10kHz	5%-90%	
	10kHz to 100kHz	10%-90%		

Specifications subject to change without notice.

ELECTRICAL SPECIFICATIONS (Cont.)

Output Characteristics (Cont.)	
Power-up state	Function output turns on. Can be switched off by changing internal jumper.
Output Impedance	50Ω ±2%, unbalanced (open when function output is off, can be switched to short by changing jumper)
Connector	BNC plug, front panel

Sync Output	
Output Voltage	TTL level (51Ω in series with a 74LS00 output)
Connector	BNC plug, front panel

Trigger, Gate Oscillation		
Trigger Source	External trigger only. Front panel BNC plug or push-button switch.	
Input Voltage	TTL level (74HC14 input with 5.1kΩ pull-up resistor). Minimum pulse width 200ns.	
Start/Stop Phase	Setting range	+360.0° to -360.0°
	Display	Maximum 4 digits + negative display, resolution 0.1° (constant)
	Jitter	150ns

Memory	
Parameters Stored in Non-volatile Memory	Frequency, FCTN (function), Mode, AMPTD range, Duty var on/off, GPIB address, DC offset on/off. Start/Stop phase, Mark wave number, Space wave number.
Number of Sets	Stores 1 set of parameters.
Battery Backup	30 days or more after full charge (stored at room temperature)

Modify Method	
Left/Right Cursor Button and Modify Dial	

Display Functions	
7 Segment LED	Oscillation frequency, GPIB address (only when GPIB option is installed), start stop phase, mark wave number, space wave number.

Presets	
If the non-volatile memory fails and the 3910 is cleared, the parameters will be set as follows:	
Frequency	1.000000kHz
FCTN OUT	On (can be set to off by switching internal short plug)
AMPTD range	-0.02V _{p-p}
DC offset	Off
Duty var	Fxd
Display select	Frequency display
FCTN (function)	Sine
GPIB Address	2 (3910/11 only)
Mark Wave Number	1
Space Wave Number	1
Mode	CONT
Start Stop Phase	0° (cursor is 0.1° column)

B.2 GPIB INTERFACE (3910/11 ONLY)

GPIB Interface		
Functions	SH1, AH1, T6, L4, SR1, RL1, PP0, DC1, DT0, C0	
Data	ASCII (7-bit)	
Delimiter	Transmission	CR or CR/LF (selectable from the front panel). EOI also sent simultaneously.
	Reception	CR, CR/LF, CR + EOI, CR/LF + EOI, or EOI
Address	0 - 30 (set by modify dial from panel face)	
Output Driver	DIO1 - DIO8, NDAC, NRFD, SRQ	Open collector
	DAV, EOI	Three-state
Local Key	Return to local function	
Connector	IEEE-488 24 pin GPIB connector, rear panel	

B.3 GENERAL

Signal Ground	The grounding pins of all input/output connectors are connected to the chassis.	
Power Supply	Voltage	AC 100V, 120V, 220V, 240±10% switch, maximum voltage 250V.
	Frequency	48Hz - 62Hz
	Power Consumption	Approx. 25VA
Ambient Temperature and Humidity	Operating Range	0° - 40°C, 10 - 90% RH (no condensation)
	When Storage	-10° to 50°C, 10% to 80% RH (no condensation)
External Dimensions	Excluding Projections	216 (W) × 132.5 (H) × 350 (D) mm
Weight	Approx. 3.2kg., 6 lbs., 12 oz.	

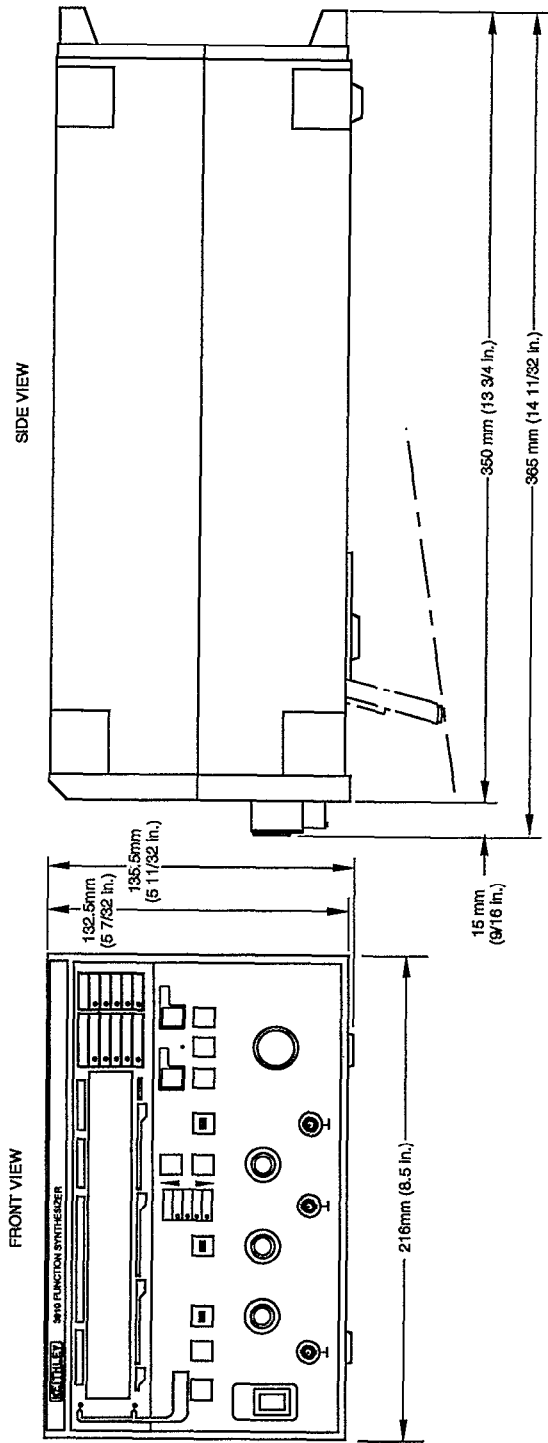

Figure B-1. Outer Dimensions of the Model 3910

Index

B

Basic Controller Functions, 4-3
Basic Listener Functions, 4-3
Basic Talker Functions, 4-3
Bus Driver, 4-6
Bus Line Signals, 4-1
burst mode, 3-10

C

Codes, 4-6
Cooling, 2-1
continuous mode, 3-9

D

DC mode, 3-11
DC Offset, 3-8
Delimiter, 4-7
Duty Cycle, 3-8

E

Error Codes, 3-7

F

Features, 1-1
Frequency Setting, 3-7
Front Panel Description, 3-1

G

GPIB Handshaking, 4-2
 GPIB Overview, 4-1
 GPIB Primary Address, 4-7
 gate mode, 3-10

H

Handling Precautions, 2-2

I

Input Connection, 3-5
Inquiry Messages, 4-8
Installation, 2-1
Interface Functions, 4-6

L

LINE Voltage Selector Switch, 2-2
Line Fuse, 2-2
Line Power Supply, 2-2
Line Receptacle Connection, 2-2

M

Major GPIB Specifications, 4-1
Manual Addenda, 1-2
Multi-line Interface Messages, 4-3
mark wave setting, 3-13

N

Numeric Format, 4-8

O

Operating Examples, 2-4
Optional Accessories, 1-3
Oscillation Mode Selection, 3-9
Output Amplitude, 3-8
Output Connections, 3-5

P

Parameter Setting Messages, 4-8
Program Codes, 4-7, 4-9
phase setting, 3-11

R

Rear Panel Description, 3-4
Repacking, 1-2
Response to Interface Messages, 4-7

S

Safety Terms and Symbols, 1-2
Sample Programs, 4-13
Service Request, 4-8
Square-Wave Duty Cycle, 3-8
Start/Stop Phase, 3-11
Startup, 3-6
Status Byte, 4-9
Synchronous Output, 3-9
space wave setting, 3-13

T

Trigger Parameters, 3-11
Typical Data, A-1
Typical Execution Times, 4-12
Typical Test Connections, 2-3
trigger mode, 3-10

U

Unpacking, 1-2

V

vents, 2-1

W

Warranty, 1-2
Waveform Selection, 3-8

KEITHLEY INSTRUMENTS

SERVICE FORM

Model No. _____ Serial No. _____ Date _____

Name and Telephone No. _____

Company _____

List all control settings, describe problem and check boxes that apply to problem. _____

- | | | |
|--|--|--|
| <input type="checkbox"/> Intermittent | <input type="checkbox"/> Analog output follows display | <input type="checkbox"/> Particular range or function bad; specify _____ |
| <input type="checkbox"/> IEEE failure | <input type="checkbox"/> Obvious problem on power-up | <input type="checkbox"/> Batteries and fuses are OK |
| <input type="checkbox"/> Front panel operational | <input type="checkbox"/> All ranges or functions are bad | <input type="checkbox"/> Checked all cables |

Display or output (circle one)

- | | |
|-----------------------------------|--|
| <input type="checkbox"/> Drifts | <input type="checkbox"/> Unable to zero |
| <input type="checkbox"/> Unstable | <input type="checkbox"/> Will not read applied input |
| <input type="checkbox"/> Overload | |

- | | |
|---|--|
| <input type="checkbox"/> Calibration only | <input type="checkbox"/> Certificate of Calibration required |
| <input type="checkbox"/> Data required | |

(attach any additional sheets as necessary.)

Show a block diagram of your measurement system including all instruments connected (whether power is turned on or not). Also, describe signal source.

Where is the measurement being performed? (factory, controlled laboratory, out-of-doors, etc.)

What power line voltage is used? _____ Ambient Temperature? _____ °F

Relative humidity? _____ Other? _____

Any additional information. (If special modifications have been made by the user, please describe.) _____

Be sure to include your name and phone number on this service form.

KEITHLEY INSTRUMENTS

Instruments Division, Keithley Instruments, Inc. • 28775 Aurora Road • Cleveland, Ohio 44139 • (216) 248-0400 • Fax: 248-6168

WEST GERMANY: Keithley Instruments GmbH • Heighofstr. 5 • Munchen 70 • 089-71002-0 • Telex: 52-12160 • Fax: 089-7100259
GREAT BRITAIN: Keithley Instruments, Ltd. • The Minster • 58, Portman Road • Reading, Berkshire RG 3 1EA • 011 44 734 575 666 • Fax: 011 44 734 596 469
FRANCE: Keithley Instruments SARL • 3 Allee des Garays • B.P. 60 • 91124 Palaiseau/Z.I. • 1-6-0115 155 • Telex: 600 933 • Fax: 1-6-0117726
NETHERLANDS: Keithley Instruments BV • Avelingen West 49 • 4202 MS Gorinchem • P.O. Box 559 • 4200 AN Gorinchem • 01830-35333 • Telex: 24 684 • Fax: 01830-30821
SWITZERLAND: Keithley Instruments SA • Kriesbachstr. 4 • 8600 Dubendorf • 01-821-9444 • Telex: 828 472 • Fax: 0222-315366
AUSTRIA: Keithley Instruments GesmbH • Rosenhugelstrasse 12 • A-1120 Vienna • (0222) 84 65 48 • Telex: 131677 • Fax: (0222) 8403597
ITALY: Keithley Instruments SRL • Viale S. Gimignano 4/A • 20146 Milano • 02-4120360 or 02-4156540 • Fax: 02-4121249